



Matériel Restauration

LES INDISPENSABLES

Mobilier, Buffet, Equipement & Service



MOBILIER & DÉCORATION - CRÉATEUR DE CONFORT

MATERIALS & DECORS

La nostra azienda è sempre alla ricerca di un equilibrio tra design, funzionalità e le più moderne tendenze di mercato. Per questo motivo i nostri prodotti sono in continua evoluzione e le nostre lavorazioni spaziano dai materiali più tradizionali fino a quelli di nuova generazione. Grazie all'ampia gamma di colorazioni disponibili per gli articoli in legno, la nostra azienda è in grado di proporre soluzioni cromatiche in linea con le aspettative di un mercato esigente e in costante evoluzione.



Our company is always looking for a balance between design, functionality and the latest market trends. This is why our products are in a constant evolution and that's why we love to link together traditional and innovative materials and components. With a wide range of wooden colors and decors, our company provides solutions that will fit into even the most demanding and high end location.

Nous cherchons constamment un équilibre entre le design, les formes et les tendances les plus modernes du marché. Pour cette raison nos produits évoluent en permanence et nos matériaux vont des plus traditionnels aux plus modernes. Grâce à la largeur de la gamme de couleurs disponibles pour les articles en métal et aux choix de finitions bois, notre société est en mesure de proposer des solutions chromatiques en ligne avec les décorations les plus en vogue dans le monde de la restauration.

Unser Unternehmen bemüht sich permanent, eine Balance zwischen Design, Funktionalität und den neuesten Markttrends zu finden. Somit sind unsere Produkte einem andauernden Entwicklungsprozess unterworfen. Hierbei verbinden wir traditionelle und moderne Materialien und Komponenten. Mit der riesigen Auswahl an Farben und Dekoren versprechen wir Lösungen, die höchsten Ansprüchen gerecht werden.

Nuestra empresa siempre esta en busca de un equilibrio entre el diseño de las formas y las últimas tendencias del mercado. Es por eso que nuestros productos estan en constante evolución y nuestros trabajos van de los mas tradicionales a los de nueva generación. Gracias a la amplia gama de acabados para los artículos en madera, nuestra empresa está en capacidad de proponer unas soluciones cromáticas que cumplen con las expectativas de un mercado exigente y en constante evolución.



LAMINATO - LAMINATED - MELAMINÉ - MELAMINHARZBESCHICHTETES HOLZ - LAMINADO

LBI	LFA	LNO	LWE	LCR	LTA	LPI	LAN	LSA	LNE	LRO	LVN
Bianco White Blanc Weiß Blanco	Faggio Beech Hêtre Buche Haya	Noce Walnut Noyer Nußbaum Nogal	Wengè	Crema Cream Crème Crema	Tabacco Tobacco Tabac Tabak Tabaco	Pistacchio Pistachio Pistache Pistazie Pistacho	Antracite Anthracite Anthracite Antrazit Antracita	Sabbia Sand Sable Sand Arena	Nebbia Fog Brouillard Nebel Niebla	Cenere di rosa Ash of roses Cendre de roses Rosé Cenizas de rosas	Nero venato Veined black Noir veiné Schwarz Negro veteadado



LEGNO STRATIFICATO HPL - HIGH PRESSURE LAMINATES - BOIS STRATIFIÉ
HOCHDRUCKSCHICHTHOLZPLATTEN - MADERA CONTRACHAPADA

SDE	SAR	SWE	SCA
Decapé Whitened Decapé Gebleicht Decapado	Ardesia Slate Ardoise Schiefer Pizarra	Wengè	Cacao Cocoa Cacao Kakao Cacao



FIRE RATED
CLASS 1



MASSELLO - SOLID WOOD - BOIS MASSIF - MASSIVHOLZ - MADERA MACIZA

MNL	MFA	MNO	MM	MWE	RAL
Naturale Natural Naturel Natur Natural	Faggio Beech Hêtre Buche Haya	Noce Walnut Noyer Nußbaum Nogal	Mogano Mahogany Acajou Mahagoni Caoba	Wengè	RAL

Le stampe dei colori dei legni e dei laminati potrebbero non essere totalmente fedeli agli originali. / The print of solid wood and laminated wood colors may not match actual finishings exactly. / L'impression des couleurs des bois massifs et melaminés ne peut pas être complètement fidèle. / Abweichungen in der Farbgebungen sind möglich. / La impresión de los colores de los varios tipos de madera y de los laminados podría ser diferentes de los originales.

BUFFET

ATHENA R/F	p. 18	ATHENA R/S	p. 30	EROS R/F	p. 36	EROS ROLL TOP	p. 48
ATHENA R/M	p. 20	ATHENA RV/S	p. 30	EROS R/M	p. 38	EROS SAL 2	p. 48
ATHENA RV/M	p. 22	ATHENA PR/S	p. 30	EROS R/L2	p. 40	EROS A2	p. 48
ATHENA RV/SD	p. 23	ATHENA BM/S	p. 31	EROS R/W	p. 41	EROS PLC	p. 48
ATHENA PR/F	p. 24	ATHENA PC/S	p. 31	EROS BM	p. 42	EROS PV	p. 49
ATHENA BM	p. 26	ATHENA SAL 3/AL	p. 32	EROS B/INFRA	p. 44	EROS TRP	p. 49
ATHENA BM/INFRA	p. 27	ATHENA SAL 3	p. 32	EROS S/INFRA	p. 45	EROS INOX	p. 50
ATHENA P/C	p. 28	ATHENA SAL 2/AL	p. 33	EROS MIX	p. 46		
ATHENA P/C INFRA	p. 29	ATHENA SAL 2	p. 33	EROS BM/PLC	p. 47		

CARRELLI SERVIZIO - SERVICE TROLLEYS

ALFA	p. 59	ARTEMIDE FLAMBÈ	p. 81	HIRA FLAMBÈ	p. 81	MERCURIO	p. 80
ALDEBARAN	p. 58	AURIGA	p. 57	MAIA	p. 68	PANDORA	p. 83
ARTEMIDE	p. 74		p. 59	MAIA BM	p. 71	SCORPIONE	p. 66
ARTEMIDE BM	p. 78	HIRA	p. 60	MAIA REF	p. 70	VENERE	p. 64
ARTEMIDE REF	p. 76	HIRA BM	p. 63	MAIA FLAMBÈ	p. 81	ZEUS	p. 82

MOBILI DI SERVIZIO - WAITER STATIONS

ALKOR AP	p. 88, 90	ALKOR B	p. 92	PERSEO A/1 - A/2	p. 96	PERSEO H/1 - H/2	p. 101
ALKOR AP B/R	p. 88	ALKOR B B/R	p. 93	PERSEO A/T - A/TA	p. 100	POLAR 2 AP	p. 94
ALKOR CH	p. 89	MEDUSA 2/2 - 2/AL	p. 104	PERSEO B - B/TA	p. 102	POLAR 2 CH	p. 95
ALKOR CH B/R	p. 89, 91	MEDUSA 3/2 - 3/AL	p. 104	PERSEO G - 75	p. 102	POLAR 2 B	p. 96

KITCHEN EQUIPMENTS

ALFA	p. 134	CERVO	p. 123	INFRA	p. 116	VEGA 50 x 50	p. 127
BETA	p. 135	DRAGONE	p. 136	PLEIADI	p. 108 - 111	VEGA GN	p. 128
BACCO	p. 132	DRAGONE RINF	p. 133	TETI	p. 126	VEGA 12 - 24 - 36	p. 130
BACCO 50 x 50	p. 127	DRAGONE V	p. 138	TORO	p. 120	VEGA 60X40	p. 131
CAPRICORNO	p. 118	ERIDE	p. 127	URANO	p. 126		
CERERE	p. 137	GEMMA	p. 122	VULCANO - INFRA	p. 112 - 115		
CERERE RINF	p. 133	IDRA	p. 126	VEGA 1/1 - 2/1	p. 124		

ARMADI INOX	
ARMADI PORTA VASSOI	p. 124
ARMADI PORTA VASCHE GN	p. 124
BUFFET	
REFRIGERAZIONE STATICA	p. 18, 20, 24, 30, 36, 38, 40
REFRIGERAZIONE VENTILATA	p. 22, 30
RISCALDAMENTO BAGNO MARIA	p. 26, 31, 42, 44, 47, 52
RISCALDAMENTO A SECCO	p. 28, 45
MIX	p. 46
COMPLEMENTI LINEA SELF-SERVICE	p. 32, 48
CARRELLI CUCINA	
CARRELLI SBARAZZO	p. 58, 134, 136, 138
CARRELLI PORTAPIATTI	p. 126
CARRELLI TRASPORTO	p. 126, 132, 134
CARRELLI CESTELLI LAVASTOVIGLIE	p. 127
CARRELLI GUERIDON	p. 56
CARRELLI PORTA VASSOI/GN	
PORTA VASSOI/TEGLIE	p. 128, 130
PORTA VASCHE GN	p. 128
CARRELLI REFRIGERATI	p. 70, 71, 82
CARRELLI SALA	
SERVIZIO	p. 60, 66, 68, 74, 127
ARROSTI/BOLLITI	p. 63, 72, 78
DOLCI/FORMAGGI	p. 62, 67, 69, 70, 74, 77
PESCE	p. 70, 71, 76, 82
FLAMBÈ	p. 80, 81
VINI/LIQUORI	p. 64, 67, 75, 76
CARRELLI TERMICI	p. 72, 78, 118, 120
MOBILI DI SERVIZIO	
DESIGN CLASSICO	p. 98, 100, 102, 104
DESIGN MODERNO	p. 88, 90, 92
INOX	p. 94, 96
SERVIZIO IN CAMERA	p. 108 - 109, 110, 111
SCALDAPIATTI	p. 122
SCALDAVIVANDE	
PIANI CALDI	p. 112
PIANI CALDI CON INFRAROSSI	p. 114
ALZATE INFRAROSSI	p. 116
TAVOLE CALDE BAGNO-MARIA	p. 123
VETRINE ESPOSITIVE	p. 84

BAIN-MARIE FOOD WARMERS	p. 123
BAIN-MARIE TROLLEYS	p. 72, 78, 118, 120
BUFFET	
STATIC REFRIGERATION	p. 18, 20, 24, 30, 3, 38, 40, 50, 82
FAN-ASSISTED REFRIGERATION	p. 22, 30
BAIN MARIE HEATING	p. 26, 31, 42, 44, 47, 52
DRY HEATING	p. 28, 45
MIX	p. 46
SELF-SERVICE FURNISHINGS	p. 32, 48
DISHWARMERS	p. 122
DISPLAY CASES	p. 84
FOOD WARMERS/INFRARED	
HOT PLATES	p. 112
CARVING STATIONS	p. 114
FREE-STAND CARVING STATIONS	p. 114
GUERIDON TROLLEYS	p. 56
KITCHEN TROLLEYS	
TABLE CLEARING TROLLEYS	p. 58, 134, 136, 138
DISH TROLLEYS	p. 126
TRANSPORT TROLLEYS	p. 126, 132, 134
DISH WASHER BASKET TROLLEYS	p. 127
RACK TROLLEYS	
TRAYS/BAKING TINS	p. 128 -130
GN PANS	p. 128
REFRIGERATED TROLLEYS	p. 70 - 71 - 82
RESTAURANT TROLLEYS	
SERVICE	p. 60, 66, 68, 74, 127
CARVING TROLLEYS	p. 63, 72, 78
DESSERT/CHEESE	p. 62, 67, 69, 70, 74, 77
FISH	p. 70, 71, 76, 82
FLAMBÈ	p. 80, 81
WINES/LIQUEURS	p. 64, 67, 75, 76
ROOM SERVICE	p. 108 - 109, 110, 111
WAITER STATIONS	
CLASSIC DESIGN	p. 98, 100, 102, 104
MODERN DESIGN	p. 88, 90, 92
STAINLESS STEEL	p. 94, 96
WARM CABINETS	
TRAYS WARM CABINETS	p. 124
GN PANS WARM CABINETS	p. 124



BUFFET

L'alternativa del pasto servito al tavolo è il concept della linea self service. Le nostre 2 linee di buffet permettono la presentazione sia di cibi caldi che freddi e possono essere completate da moltissimi accessori e componenti. I vari moduli possono essere utilizzati separatamente, ad isola, o in linea adeguandosi facilmente alle necessità di spazio e presentazione dei cibi.



The concept of a self-service line is the perfect alternative to the table service. Our 2 lines of buffets allow the presentation of both warm and cold food and can be completed by several options and components. Each element can be used individually, as an island, or in line. The modularity of these items will help you in finding the perfect solution for your needs.

Le self-service est une alternative aux repas servis à la table des plus convaincantes. Nos deux lignes de buffets permettent la présentation des aliments chauds et froids et peuvent être complétées par nombreux accessoires et composants. Les différents modules peuvent être utilisés séparément ou en ligne et s'adaptent facilement aux besoins d'espace et à la présentation des aliments.

Das Konzept der Selbstbedienung ist die perfekte alternative zum Tischservice. Unsere beiden Buffetlinien erlauben kalt und warme Präsentation und können durch Optionen ergänzt werden. Jedes Element kann einzeln oder ergänzend benutzt werden. Das modulare System hilft Ihnen, die ideale Lösung Ihrer Anforderungen zu finden.

La alternativa de la comida servida en la mesa es el concepto de la línea de self-service. Nuestras dos líneas de buffet permiten la presentación de comidas frías y calientes y pueden ser complementados por una variedad de accesorios y componentes. Los diferentes módulos se pueden utilizar por separado o en línea, adaptándose fácilmente a las necesidades de espacio y presentación de las comidas.

ATHENA



Nuova e moderna linea di carrelli buffet con soluzioni tecnologiche all'avanguardia. L'accurato accostamento di materiali diversi come legno laminato e acciaio inox rendono questi elementi non più solo un'attrezzatura professionale ma veri e propri ed eleganti complementi di arredo curati fin nei minimi dettagli. Tutti i modelli possono essere realizzati in 12 colori di legno laminato e possono essere completati da svariati optional per rispondere a qualsiasi necessità di utilizzo.



New and modern range of buffet trolleys with state-of-the-art technological solutions. The accurate combination of different materials like laminated wood, stainless steel make these units not only professional equipments but also real furnishing accessories made with attention to the smallest detail. All the models can be manufactured in 12 different laminated wood colors and can be equipped with various optionals to satisfy any needs.



Nouvelle et moderne ligne de buffets avec solutions à l'avant-garde. L'association soignée de matériaux différents comme le bois melaminé et l'acier inox rend ces éléments des véritables meubles de design et pas seulement un équipement professionnel. Tous les modèles peuvent être produits en 12 couleurs de bois melaminé et peuvent être complétés par nombreux accessoires pour répondre à tous les besoins d'utilisation.



Neue und moderne Buffet-Wagen mit innovativer und fortschrittlicher Technik. Die Kombination hochwertiger Materialien wie melaminharzbeschichtetes Holz und Edelstahl, machen diese Buffet-Wagen nicht nur zum professionellen Helfer, sondern auch zum schicken Möbelstück bzw. Blickfang. Die Funktionalität des Wagens ist bis ins kleinste Detail durchdacht. Alle Modelle können in 12 verschiedenen laminierten Holzfarben hergestellt und mit verschiedenen Optionen ausgestattet werden.



Nueva y moderna línea de carros buffet con soluciones de vanguardia tecnológica. La cuidada combinación de diferentes materiales como la madera laminada y acero inoxidable hacen de estos carros no sólo un equipo profesional, sino muebles auténticos y elegantes con atención a los más pequeños detalles. Todos los modelos se realizan en 12 colores de madera laminada y se pueden completar con varios opcionales para satisfacer cualquier necesidad de uso.



ATHENA R/F	p. 18
ATHENA R/M	p. 20
ATHENA RV/M	p. 22
ATHENA RV/SD	p. 23
ATHENA PR/F	p. 24



ATHENA BM	p. 26
ATHENA BM/INFRA	p. 27
ATHENA P/C	p. 28
ATHENA P/C INFRA	p. 29



ATHENA R/S	p. 30
ATHENA RV/S	p. 30
ATHENA PR/S	p. 30
ATHENA BM/S	p. 31
ATHENA PC/S	p. 31



ATHENA SAL 3/AL	p. 32
ATHENA SAL 3	p. 32
ATHENA SAL 2/AL	p. 33
ATHENA SAL 2	p. 33

OPTIONALS

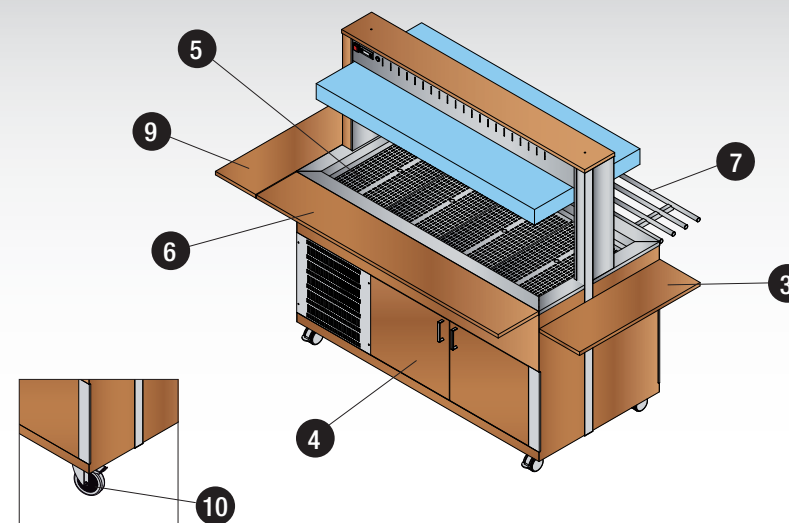



ATHENA 3 R/F



ATHENA 4 R/F

OPTIONALS



OPT. 3



OPT. 4

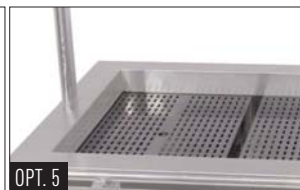

OPT. 5



OPT. 6



OPT. 7



OPT. 9



OPT. 10

ø 125



ATHENA 3 R/F GN H 200 1/1 1/1 1/1

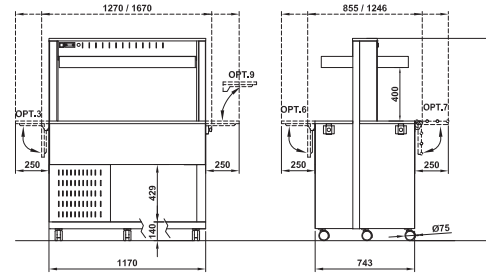

ATHENA 4 R/F GN H 200 1/1 1/1 1/1 1/1

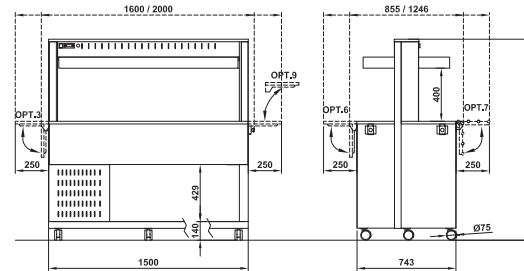

ATHENA 5 R/F GN H 200 1/1 1/1 1/1 1/1 1/1

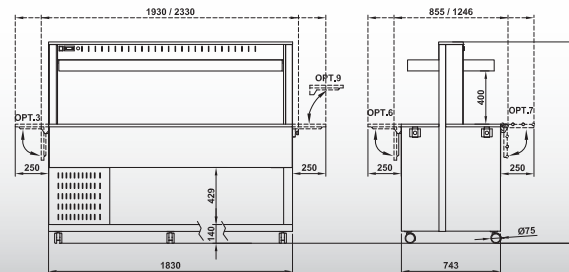

ATHENA	GN H 200	⚡ 230V max	OPTIONALS
ATHENA 3 R/F	3 GN 1/1	340 W	3-4-5-6-7-9-10
ATHENA 4 R/F	4 GN 1/1	344 W	3-4-5-6-7-9-10
ATHENA 5 R/F	5 GN 1/1	348 W	3-4-5-6-7-9-10



CONFIGURA IL TUO CARRELLO
BUILD YOUR TROLLEY ON
www.rocam.it



Buffet refrigerati con struttura in legno laminato. Calottina superiore in Plexiglass fissa (R/F). Vasca profonda 26 cm. con rubinetto di scarico. Refrigerazione statica gas R404a. Termostato digitale (+2°/+8°C). Illuminazione a LED. Due ruote in poliammide con freno di serie.



Refrigerated buffets with laminated wood structure. Upper in Plexiglass sneezeguard fixed (R/F). Well 26 cm. deep with drain cock. Static refrigeration of the well, gas R404a. Digital thermostat (+2°/+8°C) and lighting with LED. Two polyamide castors with brake included.



Buffets réfrigérés avec une structure en bois mélaminé. Calotte supérieure en Plexiglass fixe (R/F). Bac profonde 26 cm. avec robinet de vidange. Refroidissement statique gaz R404a. Thermostat numérique (+2°/+8°C) et éclairage à LED. Deux roues à frein en polyamide de série.



Kühl-Bufferwagen aus melaminharzbeschichtetem Holz. Das Plexiglasdach ist fest montiert (R/F). Die Edelstahlwanne AISI 304 ist 26 cm tief und mit einem Ablasshahn ausgestattet. Die statische Kühlung des Wagens wird über ein Thermostat geregelt (+2°/+8°C). Der Wagen hat eine energiesparende LED Beleuchtung. Inklusive 4 Lenkrollen, davon 2 Bremsrollen.



Buffet refrigerados con estructura en madera laminada. Tapa superior en Plexiglass fija (R/F). Cuba profunda 26 cm equipada con grifo de drenaje. Refrigeración estática, gas R404a. Termostato digital (+2°/+8°C). Iluminación LED. 2 Ruedas de poliamida con freno incluidas.



ATHENA 4 R/M



ATHENA 5 R/M

OPTIONALS



OPT. 3



OPT. 4



OPT. 5



OPT. 6

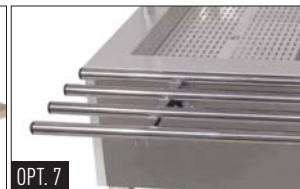

OPT. 7



OPT. 9



OPT. 10

ø 125



SICUREZZA ANTISCHIACCIAMENTO
ANTI PINCH SAFETY SYSTEM

ATHENA 3 R/M GN H 200 1/1 1/1 1/1

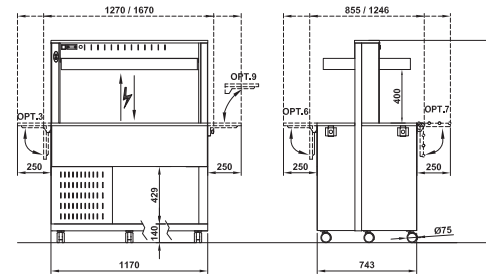

ATHENA 4 R/M GN H 200 1/1 1/1 1/1 1/1

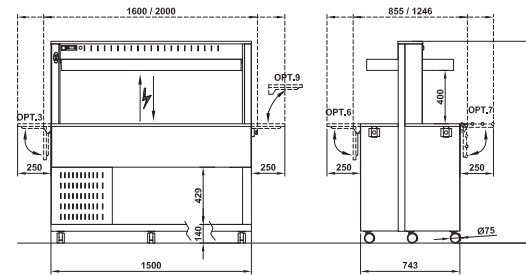

ATHENA 5 R/M GN H 200 1/1 1/1 1/1 1/1 1/1

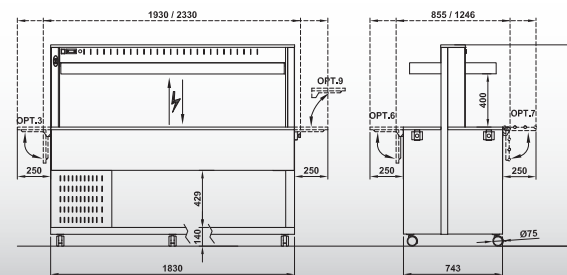

ATHENA	GN H 200	⚡ 230V max	OPTIONALS
ATHENA 3 R/M	3 GN 1/1	490 W	3-4-5-6-7-9-10
ATHENA 4 R/M	4 GN 1/1	494 W	3-4-5-6-7-9-10
ATHENA 5 R/M	5 GN 1/1	498 W	3-4-5-6-7-9-10



CONFIGURA IL TUO CARRELLO
BUILD YOUR TROLLEY ON
www.rocam.it



Buffet refrigerati con struttura in legno laminato. Calottina abbassabile elettricamente (R/M). Vasca profonda 26 cm. con rubinetto di scarico. Refrigerazione statica gas R404a. Termostato digitale (+2°/+8°C). Illuminazione a LED. Due ruote in poliammide con freno di serie.



Refrigerated buffets with laminated wood structure. Upper sneezeguard mobile with electrical system (R/M). Well 26 cm. deep with drain cock. Static refrigeration of the well, gas R404a. Digital thermostat (+2°/+8°C) and lighting with LED. Two polyamide castors with brake included.



Buffets réfrigérés avec une structure en bois mélaminé. Calotte supérieure abaissable électriquement (R/M). Bac profonde 26 cm. avec robinet de vidange. Refroidissement statique gaz R404a. Thermostat numérique (+2°/+8°C) et éclairage à LED. Deux roues à frein en polyamide de série.



Kühl-Bufferwagen aus melaminharzbeschichtetem Holz. Das Plexiglasdach ist mobil mit elektrischem Hebe- und Senksystem (R/M) erhältlich. Die Edelstahlwanne AISI 304 ist 26 cm tief und mit einem Ablasshahn ausgestattet. Die statische Kühlung des Wagens wird über ein Thermostat geregelt (+2°/+8°C). Der Wagen hat eine energiesparende LED Beleuchtung. Inklusive 4 Lenkrollen, davon 2 Bremsrollen.



Buffet refrigerados con estructura en madera laminada. Tapa superior móvil eléctricamente (R/M). Cuba profunda 26 cm equipada con grifo de drenaje. Refrigeración estática, gas R404a. Termostato digital (+2°/+8°C). Iluminación LED. 2 Ruedas de poliamida con freno incluidas.

REFRIGERATO VENTILATO - VENTILATED REFRIGERATION



AUTO DEFROST



ATHENA 4 RV/M



ATHENA 3 RV/M GN H 200 1/1 1/1 1/1

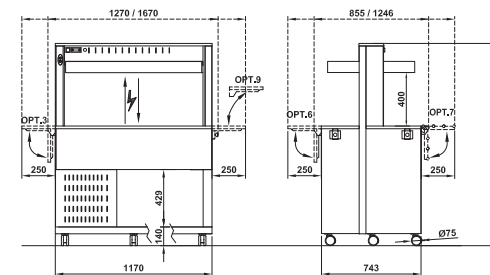

ATHENA 4 RV/M GN H 200 1/1 1/1 1/1 1/1

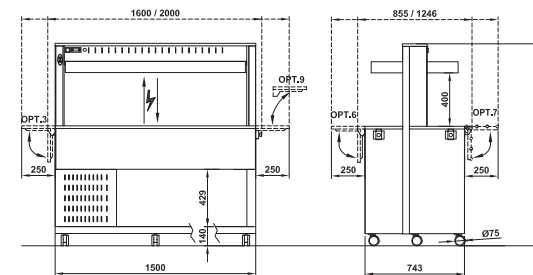

ATHENA 5 RV/M GN H 200 1/1 1/1 1/1 1/1 1/1

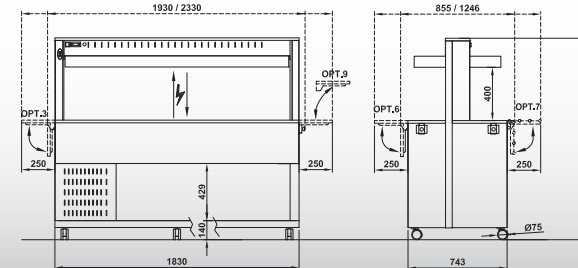

OPTIONALS





ATHENA 5 RV/SD



ATHENA	GN H 200	⚡ 230V _{max}	OPTIONALS
ATHENA 3 RV/M	3 GN 1/1	R 933W - D 1153W*	3-4-5-6-7-9-10
ATHENA 4 RV/M	4 GN 1/1	R 948W - D 1168W*	3-4-5-6-7-9-10
ATHENA 5 RV/M	5 GN 1/1	R 963W - D 1183W*	3-4-5-6-7-9-10
ATHENA 5 RV/SD	5 GN 1/1	R 813W - D 1033W*	3-5-6-7-9-10

* R = REFRIGERATION CYCLE D = DEFROST CYCLE



ATHENA 5 RV/SD GN H 200 1/1 1/1 1/1 1/1 1/1

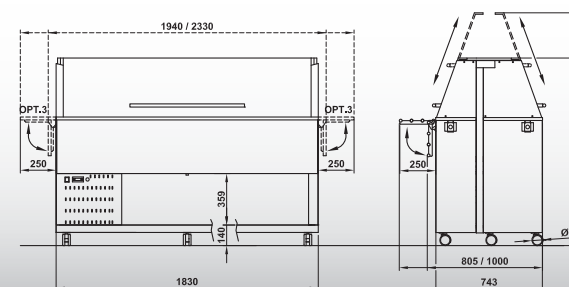

CONFIGURA IL TUO CARRELLO
BUILD YOUR TROLLEY ON
www.rocam.it



Buffet refrigerati con struttura in legno laminato. Termostato digitale (+2°/+8°C). Illuminazione a LED. Due ruote in poliammide con freno di serie. RV/M: Calottina superiore abbassabile elettricamente. RV/SD: Calottina con doppia anta scorrevole verso l'alto con meccanismo di frenata per evitare chiusure improwise.



Refrigerated buffets with laminated wood structure. Digital thermostat (+2°/+8°C). Lighting with LED. Two polyamide castors with brake included. RV/M: Upper mobile sneezeguard with electrical system. RV/SD: sneezeguard with sliding doors opening upwards fitted with a mechanism to secure them against falling back.



Buffets réfrigérés avec une structure en bois melaminé. Thermostat numérique (+2°/+8°C). Éclairage à LED. Deux roues à frein en polyamide de série. RV/M: Calotte supérieure abaissable électriquement. RV/SD: avec double portes glissantes vers le haut.



Kühl-Bufferwagen aus melaminharbeschichtetem Holz. Die Temperatur wird durch ein Thermostat geregelt (+2°/+8°C). Energiesparende LED Beleuchtung. Inklusive 4 Lenkrollen, davon 2 Bremsrollen. Bei den Modellen RV/M ist das Plexiglasdach mit einem elektrischen Heb- und Senksystem ausgestattet. RV/SD: Mit Öffnung nach oben der Plexy-doppel tueren.



Buffet refrigerados con estructura en madera laminada. Termostato digital (+2°/+8°C). Iluminación LED. 2 Ruedas de poliamida con freno incluidas. RV/M: Tapa superior móvil eléctricamente. RV/SD: con doble puerta deslizante hasta arriba.



ATHENA 3 PR/F



ATHENA 5 PR/F

OPTIONALS



OPT. 3



OPT. 4



OPT. 6

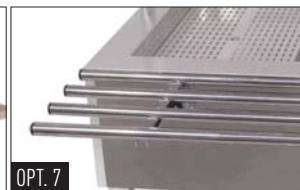

OPT. 7



OPT. 9



OPT. 10

ø 125

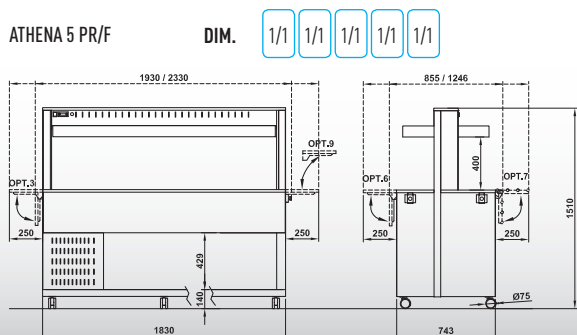
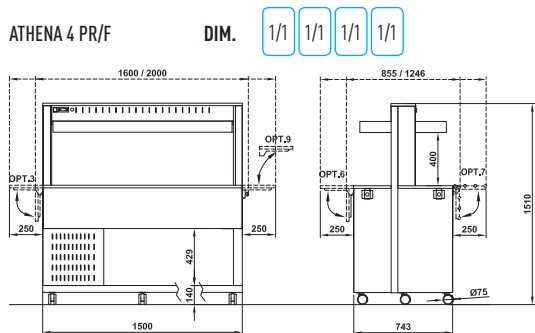
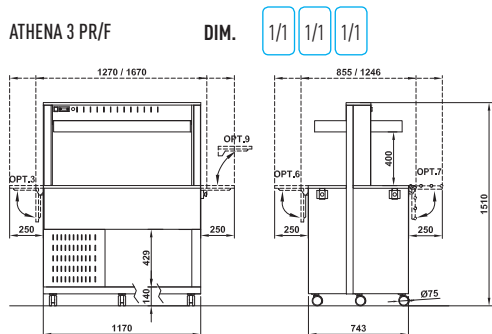

ATHENA	DIM.	⚡ 230V max	OPTIONALS
ATHENA 3 PR/F	3 GN 1/1	340 W	3-4-6-7-9-10
ATHENA 4 PR/F	4 GN 1/1	344 W	3-4-6-7-9-10
ATHENA 5 PR/F	5 GN 1/1	348 W	3-4-6-7-9-10



CONFIGURA IL TUO CARRELLO
BUILD YOUR TROLLEY ON
www.rocam.it



Buffet refrigerati con struttura in legno laminato. Termostato digitale (+2°/+8°C). Illuminazione a LED. Due ruote in poliammide con freno di serie. PR/F: Calottina superiore fissa, piano refrigerato in Hanex® (antibatterico, non poroso e facile da pulire) con gas R404a, cornice in acciaio inox.



Refrigerated buffets with laminated wood structure. Digital thermostat (+2°/+8°C). Lighting with LED. Two polyamide castors with brake included. PR/F: Upper fixed sneezeguard, refrigerated countertop made of Hanex® (antibacterial, non porous and easy to clean) with static refrigeration gas R404a, frame made of s/steel.



Buffets réfrigérés avec une structure en bois melaminé. Thermostat numérique (+2°/+8°C). Éclairage à LED. Deux roues à frein en polyamide de série. P/R/F: Calotte supérieure fixe, étagère réfrigérée en Hanex® (antibactérien, non-poreux et de facile nettoyage) avec refroidissement statique gaz R404a, châssis en acier inox.



Kühl-Bufferwagen aus melaminharzbeschichtetem Holz. Die Temperatur wird durch ein Thermostat geregelt (+2°/+8°C). Energiesparende LED Beleuchtung. Inklusive 4 Lenkrollen, davon 2 Bremsrollen. PR/F: Obere feste Plexiglashaube, gekühlte Arbeitsplatte aus Hanex® (antibakteriell, nicht porös und leicht zu reinigen) mit statischer Kühlung, R404a, Rahmen aus Edelstahl AISI 304.



Buffet refrigerados con estructura en madera laminada. Termostato digital (+2°/+8°C). Iluminación LED. 2 Ruedas de poliamida con freno incluidas. PR/F: Tapa superior fija, estante refrigerado en Hanex® (anti-bacterial, no poroso y fácil de limpiar) con gas R404a, marco en acero inox.



ATHENA 5 BM

ATHENA 3 BM GN H 200 1/1 1/1 1/1

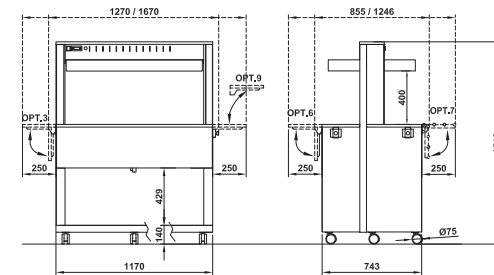

ATHENA 4 BM GN H 200 1/1 1/1 1/1 1/1

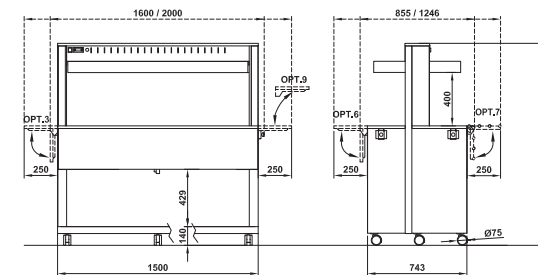

ATHENA 5 BM GN H 200 1/1 1/1 1/1 1/1 1/1

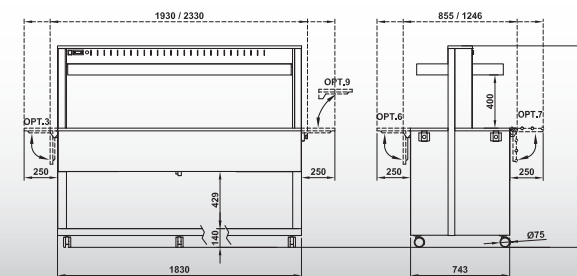

OPTIONALS

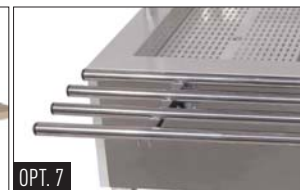

Ø 125

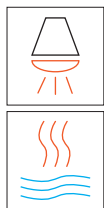

ATHENA 3 BM/INFRA

ATHENA 3 BM/INFRA GN H 200 1/1 1/1 1/1

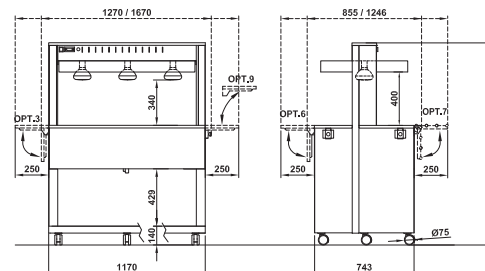

ATHENA 4 BM/INFRA GN H 200 1/1 1/1 1/1 1/1

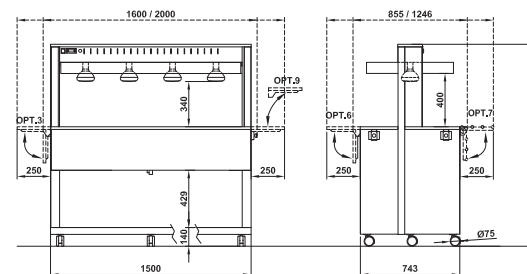

ATHENA 5 BM/INFRA GN H 200 1/1 1/1 1/1 1/1 1/1

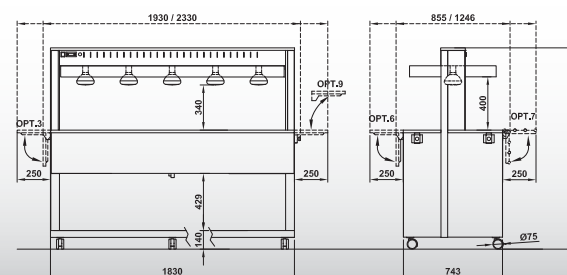

ATHENA	GN H 200	⚡ 230V max	OPTIONALS
ATHENA 3 BM	3 GN 1/1	2262 W	3-4-6-7-9-10
ATHENA 4 BM	4 GN 1/1	3016 W	3-4-6-7-9-10
ATHENA 5 BM	5 GN 1/1	3022 W	3-4-6-7-9-10
ATHENA 3 BM/INFRA	3 GN 1/1	3000 W	3-4-6-7-9-10
ATHENA 4 BM/INFRA	4 GN 1/1	4000 W	3-4-6-7-9-10
ATHENA 5 BM/INFRA	5 GN 1/1	4250 W	3-4-6-7-9-10



CONFIGURA IL TUO CARRELLO
BUILD YOUR TROLLEY ON
www.rocam.it



Buffet riscaldati con struttura in legno laminato. Calottina superiore fissa. Vasca profonda 26 cm. con rubinetto di scarico. Riscaldamento a bagnomaria con termostato digitale. Illuminazione a LED. Due ruote in poliammide con freno di serie. ATHENA BM/INFRA: con lampade infrarossi ad accensione indipendente con pulsante luminoso.



Heated buffets, laminated wood structure. Upper fixed sneeze-guard. Well 26 cm. deep with drain cock. Bain marie heating and digital thermostat. Lighting with LED. Two castors with brake included. ATHENA BM/INFRA: equipped with infrared lamps over the well with independent lighting switch.



Buffets chauffés avec structure en bois mélaminé. Calotte supérieure fixe. Bac profonde 26 cm. avec robinet de vidange. Chauffage à bainmarie et thermostat numérique. Éclairage à LED. Deux roues à frein en polyamide de série. ATHENA BM/INFRA: avec lampes à infrarouges et avec interrupteur indépendant avec bouton lumineux.



Bain Marie Buffetwagen aus melaminharzbeschichtetem Holz. Das Plexiglasdach ist fest montiert. Die Edelstahlwanne AISI 304 ist 26 cm tief und mit einem Ablasshahn ausgestattet. Die Bain Marie Beheizung arbeitet mit Heizelementen, die unter der Wanne angebracht sind. Die Temperatur wird durch ein digitales Thermostat gesteuert. LED-Beleuchtung. Inklusive 4 Lenkrollen, davon 2 als Bremsrolle. Das Modell ATHENA BM / INFRA ist mit Infrarot-Lampen über der Wanne und einem separaten Schalter ausgestattet.



Buffet calientes con estructura de madera laminada. Tapa superior fija. Cuba profunda 26 cm equipada con grifo de drenaje. Calentamiento baño maría con termostato digital. Iluminación LED. Dos ruedas de poliamida con freno incluidas. ATHENA BM/INFRA: equipado con lámparas infrarrojos con botón de encendido independiente.

PIANO RISCALDATO - HEATED COUNTERTOP



ATHENA 3 PC

ATHENA 3 PC DIM. 1/1 1/1 1/1

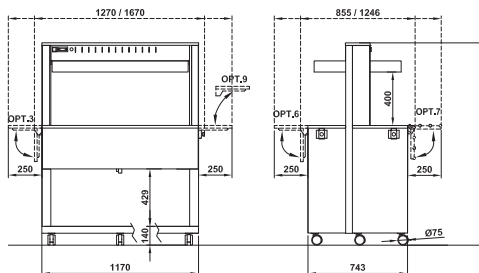

ATHENA 4 PC DIM. 1/1 1/1 1/1 1/1

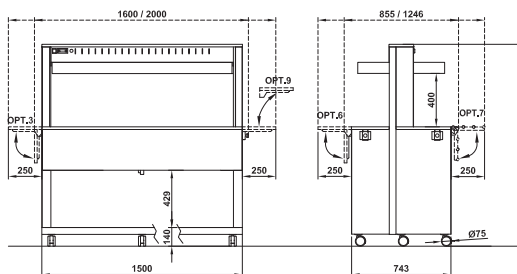

ATHENA 5 PC DIM. 1/1 1/1 1/1 1/1 1/1

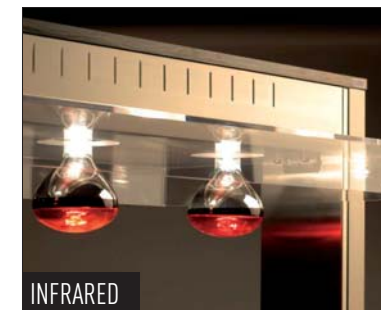
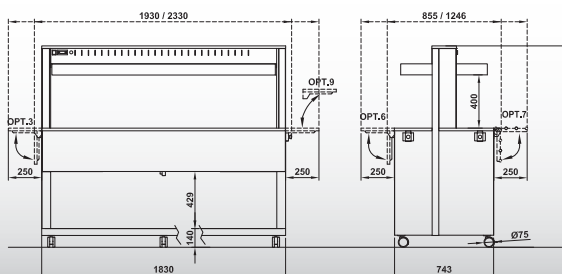

INFRARED



VETRO TEMPERATO
TEMPERED GLASS

OPTIONALS



OPT. 3



OPT. 4



OPT. 6



OPT. 7



OPT. 9



OPT. 10

Ø 125



ATHENA 4 PC/INFRA

ATHENA 3 PC/INFRA DIM. 1/1 1/1 1/1

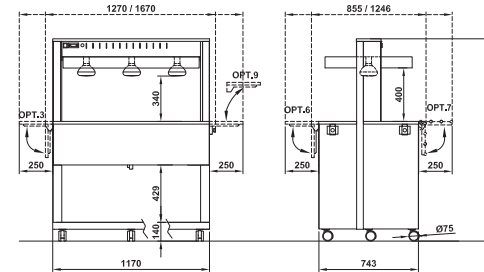

ATHENA 4 PC/INFRA DIM. 1/1 1/1 1/1 1/1

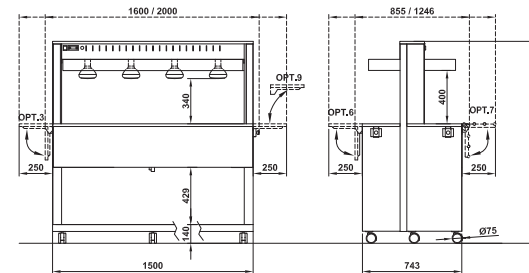

ATHENA 5 PC/INFRA DIM. 1/1 1/1 1/1 1/1 1/1

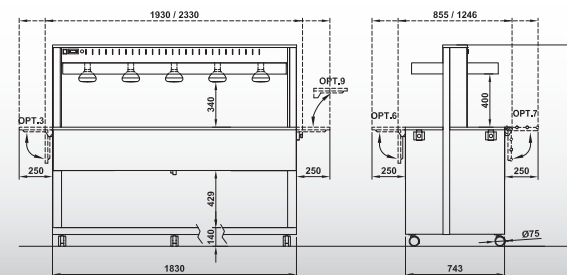

ATHENA	DIM.	⚡ 230V max	OPTIONALS
ATHENA 3 PC	3 GN 1/1	2250 W	3-4-6-7-9-10
ATHENA 4 PC	4 GN 1/1	3000 W	3-4-6-7-9-10
ATHENA 5 PC	5 GN 1/1	3020 W	3-4-6-7-9-10
ATHENA 3 PC/INFRA	3 GN 1/1	2250 W	3-4-6-7-9-10
ATHENA 4 PC/INFRA	4 GN 1/1	3000 W	3-4-6-7-9-10
ATHENA 5 PC/INFRA	5 GN 1/1	4270 W	3-4-6-7-9-10



CONFIGURA IL TUO CARRELLO
BUILD YOUR TROLLEY ON
www.rocam.it



Buffet riscaldati con struttura in legno laminato. Calottina superiore fissa. Piano in vetro temperato nero con cornice in acciaio inox. Riscaldamento a secco con termostato digitale. Illuminazione a LED. Due ruote in poliammide con freno di serie.

ATHENA PC/INFRA: con lampade infrarossi ad accensione indipendente con pulsante luminoso.



Heated buffets, laminated wood structure. Upper fixed sneezeguard. Tempered black glass countertop with stainless steel frame. Dry-heating with digital thermostat. Lighting with LED. Two castors with brake included.

ATHENA PC/INFRA: equipped with infrared lamps over the countertop with independent lighting switch.



Buffets chauffés avec structure en bois mélaminé. Calotte supérieure fixe. Étagère en verre trempé noir avec châssis en acier inox. Chauffage à sec et thermostat numérique. Éclairage à LED. Deux roues à frein en polyamide de série.

ATHENA PC/INFRA: avec lampes à infrarouges et interrupteur indépendant avec bouton lumineux.



Beheizte Glasschränke mit laminierter Holzstruktur. Das Plexiglasdach ist fest montiert. Die Arbeitsplatte ist aus ESG Schwarzglas mit Edelstahlrahmen AISI 304. Chemische-Heizung mit einem Heizkörper unter der Arbeitsplatte. Temperatursteuerung durch einen digitalen Thermostat. Beleuchtung mit LEDlampe. 4 Lenkrollen, davon 2 Rollen mit Bremse enthalten. ATHENA PC/INFRA: ausgestattet mit Infrarot-Lampen über der Arbeitsplatte mit separatem Schalter.



Buffet calientes con estructura de madera laminada. Tapa superior fija. Estante de vidrio temperado negro con marco en acero inox. Calentamiento en seco con termostato digital. Iluminación LED. Dos ruedas de poliamida con freno incluidas.

ATHENA PC/INFRA: equipado con lámparas infrarrojas con botón de encendido independiente.

SERVITO REFRIGERATO - REFRIGERATED WITH OPERATOR



ATHENA 3 R/S GN H 200 1/1 1/1 1/1

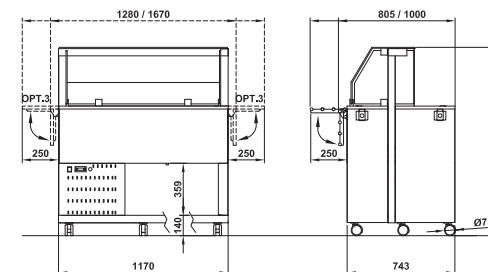

ATHENA 4 R/S GN H 200 1/1 1/1 1/1 1/1

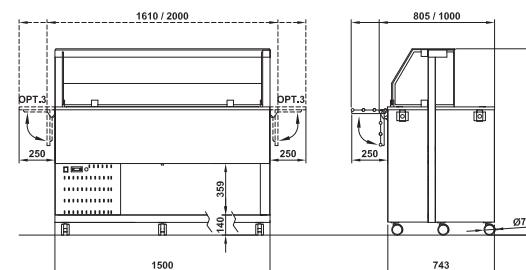

ATHENA 5 R/S GN H 200 1/1 1/1 1/1 1/1 1/1

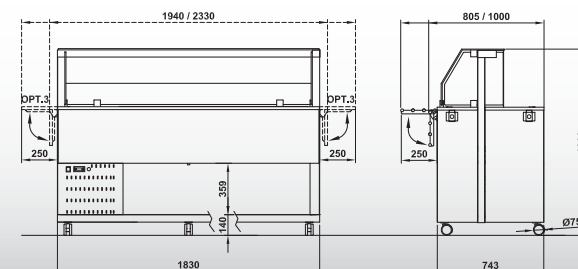

ATHENA RV/S

 DISPONIBILE ANCHE CON REFRIGERAZIONE VENTILATA
AVAILABLE ALSO WITH VENTILATED REFRIGERATION

ATHENA PR/S

 DISPONIBILE ANCHE CON PIANO REFRIGERATO
AVAILABLE ALSO WITH REFRIGERATED COUNTERTOP

ATHENA 5 R/S

OPTIONALS



OPT. 3



OPT. 4



OPT. 5



OPT. 10

Ø 125



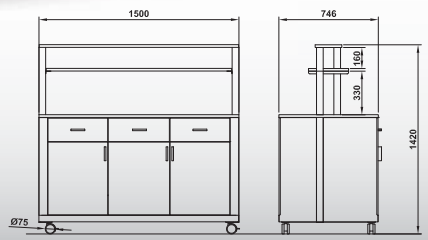

ATHENA SAL 3/AL

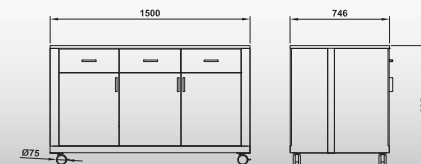

ATHENA SAL 3



DIVISORI INTERNI
INNER DIVIDERS FOR CUTLERY



ATHENA		
ATHENA SAL 3/AL	3	3
ATHENA SAL 3	3	3
ATHENA SAL 2/AL	2	2
ATHENA SAL 2	2	2



CONFIGURA IL TUO CARRELLO
BUILD YOUR TROLLEY ON
www.rocam.it

ATHENA SAL 2/AL

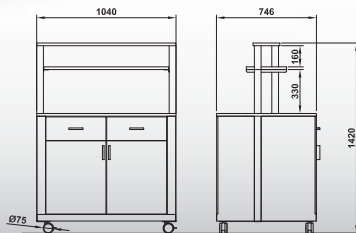

ATHENA SAL 2

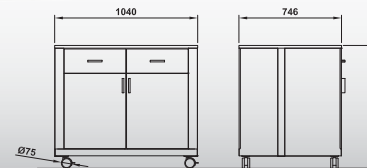

Buffet neutri con struttura in legno laminato e top in acciaio inox AISI 304 per completare la linea self-service. Ogni vano chiuso da sportello ha un ripiano regolabile in altezza all'interno.
ATHENA SAL/2 – ATHENA SAL/3: 2 o 3 cassetti con divisori interni e 2 o 3 vani con sportelli.
ATHENA SAL 2/AL – ATHENA SAL 3/AL: 2 o 3 cassetti con divisori interni, 2 o 3 vani con sportelli e alzata con 2 piani in laminato.



Neutral buffet to completion of the self-service line with laminated wood structure and stainless steel AISI 304 countertop. Each space closed by a door has an adjustable shelf inside.
ATHENA SAL/2 – ATHENA SAL/3: 2 or 3 drawers with internal dividers and 2 or 3 doors.
ATHENA SAL 2/AL – ATHENA SAL 3/AL: 2 or 3 drawers with internal dividers and 2 or 3 doors. Upper part with 2 laminated wood shelves.



Buffets neutres pour achever la ligne self service, structure en bois melaminé et top en acier inox AISI 304. Chaque compartiment fermé par porte à un étagère réglable en hauteur à l'intérieur.
ATHENA SAL/2 – ATHENA SAL/3: 2 ou 3 tiroirs avec séparateurs à l'intérieur et 2 ou 3 portes.
ATHENA SAL 2/AL – ATHENA SAL 3/AL: 2 ou 3 tiroirs avec séparateurs à l'intérieur et 2 ou 3 portes et partie supérieure à 2 étages en bois melaminé.



Neutraler Buffetwagen mit laminiertes Holzstruktur und Edelstahloberfläche AISI 304. Jedes Raum mit Tür ist mit einer verstellbare Fläche ausgestattet.
ATHENA SAL/2 – ATHENA SAL/3: 2 oder 3 Schubladen mit inneren Trennwänden und 2 oder 3 Räumen mit Türen.
ATHENA SAL 2/AL – ATHENA SAL 3/AL: 2 oder 3 Schubladen mit inneren Trennwänden und 2 oder 3 Räumen mit Türen. Ausgestattet mit zwei Regalen aus melaminharzbeschichtetem Holz.



Buffet neutros con estructura en madera laminada y top en acero inox AISI 304 para completar la línea self-service. Cada compartimento cerrado con puerta tiene un estante regulable al interior.
ATHENA SAL/2 – ATHENA SAL/3: 2 o 3 cajones con separadores internos y 2 o 3 compartimentos con puertas.
ATHENA SAL 2/AL – ATHENA SAL 3/AL: 2 o 3 cajones con separadores internos y 2 o 3 compartimentos con puertas. Estructura superior con 2 estantes en madera laminada.

EROS



La nostra storica linea di carrelli buffet vanta una vastissima scelta di personalizzazioni, la maggior parte degli elementi può essere realizzata in 12 colori di legno laminato oppure totalmente in acciaio inox AISI 304. Tutti i buffet possono essere completati da svariati optional per rispondere a qualsiasi necessità di utilizzo.



Our historical line of buffet trolleys boasts of a vast choice of customizations, most of the elements can be manufactured in 12 colors of laminated wood or completely in AISI 304 stainless steel. All the buffets can be equipped with many optionals in order to meet all the possible requirements.



Notre ligne historique de buffet qui compte une vaste gamme de propositions, la plupart disponible en 12 couleurs de bois melaminé ou produite complètement en acier inox AISI 304. Tous les buffets peuvent être achevés par nombreux accessoires pour répondre à tous besoins.



Unsere traditionsreiche Serie der Buffetwagen EROS verfügt über eine große Auswahl an Ausstattungen. Viele der Elemente können aus melaminharzbeschichtetem Holz in 12 Farbgebungen oder komplett in Edelstahl AISI 304 gefertigt werden. Für unterschiedlichsten Anforderungen kann der Wagen mit vielen verschiedenen Optionen ausgestattet werden.



Nuestra histórica línea de carros buffet tiene una amplia gama de servicios personalizados, la mayoría de los elementos se pueden realizar en 12 colores de madera laminada o totalmente en acero inoxidable AISI 304. Todos los buffets se pueden completar con varios opcionales para satisfacer a cualquier necesidad de uso.



EROS R/F	p. 36
EROS R/M	p. 38
EROS R/L2	p. 40
EROS R/W	p. 41



EROS BM	p. 42
EROS B/INFRA	p. 44
EROS S/INFRA	p. 45



EROS MIX	p. 46
EROS BM/PLC	p. 47
EROS ROLL TOP	p. 47



EROS SAL 2	p. 48
EROS A2	p. 48
EROS PLC	p. 48
EROS PV	p. 49
EROS TRP	p. 49



EROS INOX	p. 50
-----------	-------

OPTIONALS

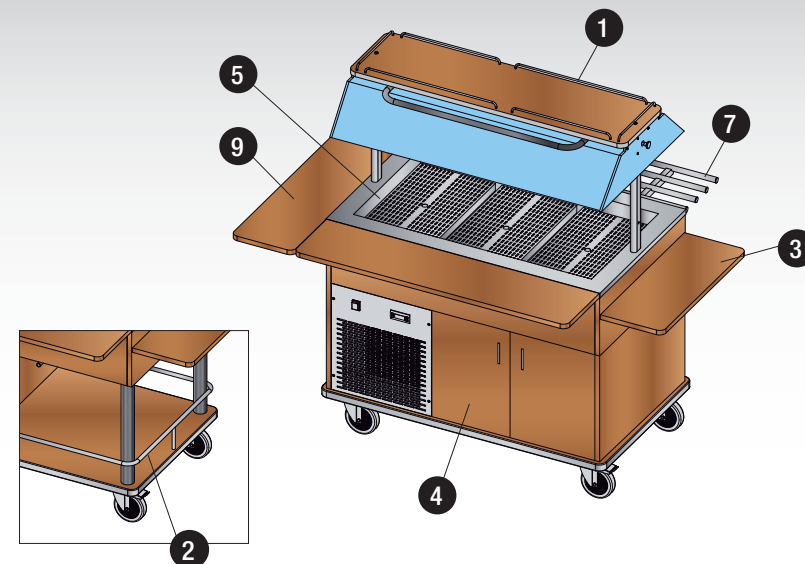



EROS 3 R/F



EROS 4 R/F

EROS 3 R/F GN H 150 1/1 1/1 1/1

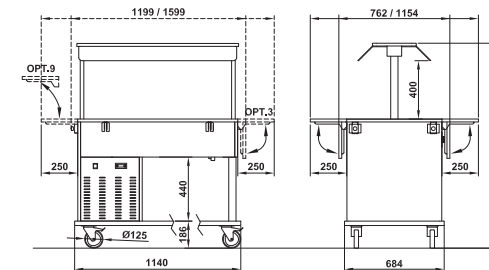

EROS 4 R/F GN H 150 1/1 1/1 1/1 1/1

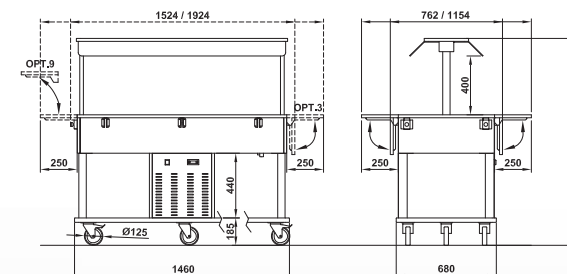

INOX VERSION >> pag. 50

OPTIONALS



OPT. 1



OPT. 2



OPT. 3



OPT. 4



OPT. 5



OPT. 7



OPT. 8



OPT. 9



EROS 5 R/F

EROS 5 R/F GN H 150 1/1 1/1 1/1 1/1 1/1

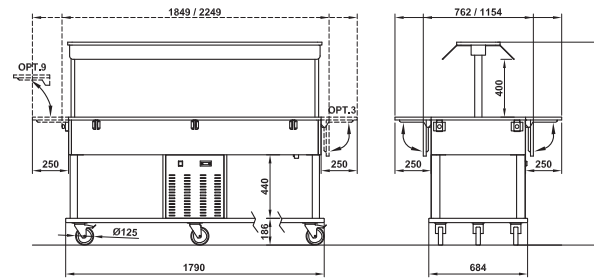

EROS 6 R/F GN H 150 1/1 1/1 1/1 1/1 1/1 1/1

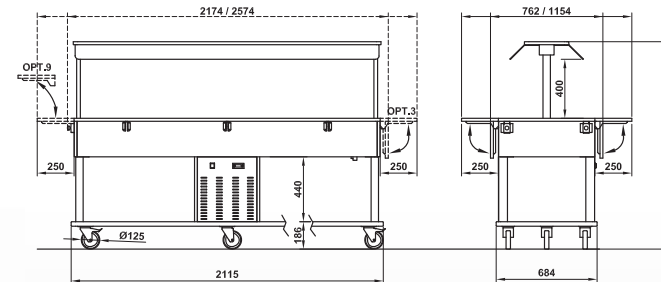

EROS	GN H 150	⚡ 230V max	OPTIONALS
EROS 3 R/F	3 GN 1/1	349 W	1-2-3-4-5-7-8-9-GN
EROS 4 R/F	4 GN 1/1	356 W	1-2-3-4-5-7-8-9-GN
EROS 5 R/F	5 GN 1/1	356 W	1-2-3-4-5-7-8-9-GN
EROS 6 R/F	6 GN 1/1	370 W	1-2-3-4-5-7-8-9-GN



LBI	LFA	LNO	LWE	LCR	LTA
LPI	LAN	LSA	LNE	LRO	LNV

CONFIGURA IL TUO CARRELLO
BUILD YOUR TROLLEY ON
www.rocam.it



Buffet refrigerati con struttura in legno laminato o in acciaio inox. Calottina superiore fissa. Due portapiatti ribaltabili di serie. Vasca profonda 18 cm. con rubinetto di scarico. Refrigerazione statica gas R404a. Termostato digitale e lampada al neon. Due ruote con freno di serie.



Refrigerated buffets, laminated wood structure or stainless steel structure. Upper fixed sneezeguard. Two frontal tip-up dish-holders included. Well 18 cm. deep with drain cock. Static refrigeration of the well, gas R404a. Digital thermostat. Lighting with neon lamp. Two castors with brake included.



Buffets réfrigérés avec structure en bois melaminé ou complètement en acier inox. Calotte supérieure fixe. Deux porte-assiettes rabattables sur les côtés principaux de série. Bac profonde 18 cm. avec robinet de vidange. Refroidissement statique gaz R404a. Thermostat numérique. Éclairage à neon. Deux roues à frein de série.



Kühl-Bufferwagen aus melaminharzbeschichtetem Holz oder aus Edelstahl. Das Plexiglasdach ist fest montiert. An beiden Längsseiten sind abklappbare zusätzliche Abstellflächen angebracht. Die Edelstahlwanne AISI 304 ist 18 cm tief und mit einem Ablasshahn ausgestattet. Die statische Kühlung der Wanne wird durch einen digitalen Thermostat geregelt. Zur Beleuchtung dient eine Neon-Leuchte. Inklusive 4 Lenkrollen, davon 2 als Bremsrolle.



Buffet refrigerados con estructura en madera laminada o totalmente en acero inoxidable AISI 304. Tapa superior en Plexiglass fija. Dos portaplatos plegables incluidos. Cuba en acero inoxidable profundidad 18 cm equipada con grifo de drenaje. Refrigeración estática con bobina soldada en la cuba y gas R404a. Regulación de temperatura con termostato digital. Iluminación de temperatura con lámpara de neón. Dos ruedas con freno incluidas.



EROS 3 R/M



EROS 4 R/M

EROS 3 R/M GN H 150 1/1 1/1 1/1

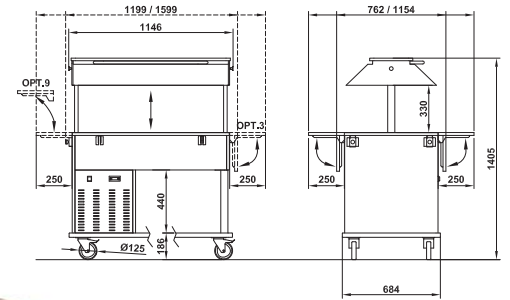

EROS 4 R/M GN H 150 1/1 1/1 1/1 1/1

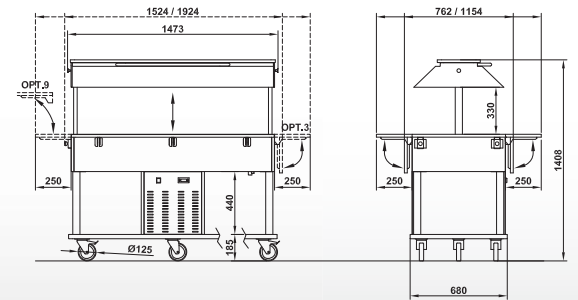

OPTIONALS



EROS 5 R/M GN H 150 1/1 1/1 1/1 1/1

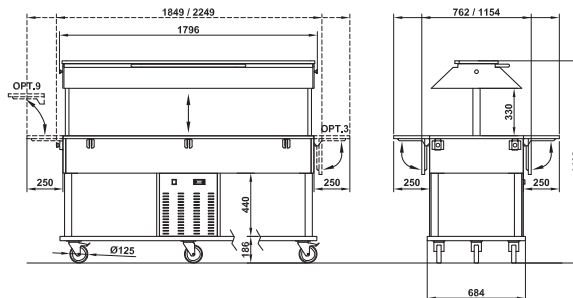

EROS 6 R/M GN H 150 1/1 1/1 1/1 1/1 1/1

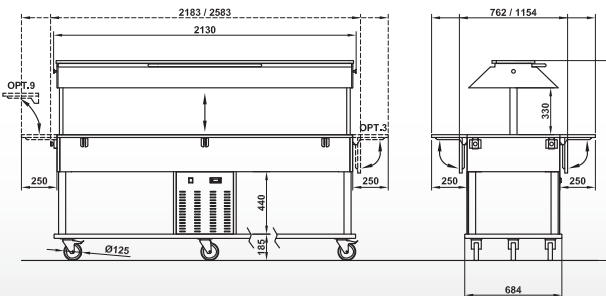

EROS	GN H 150	⚡ 230V _{max}	OPTIONALS
EROS 3 R/M	3 GN 1/1	349 W	1-2-3-4-5-7-8-9-GN
EROS 4 R/M	4 GN 1/1	356 W	1-2-3-4-5-7-8-9-GN
EROS 5 R/M	5 GN 1/1	356 W	1-2-3-4-5-7-8-9-GN
EROS 6 R/M	6 GN 1/1	370 W	1-2-3-4-5-7-8-9-GN



LBI	LFA	LNO	LWE	LCR	LTA
LPI	LAN	LSA	LNE	LRO	LNV

CONFIGURA IL TUO CARRELLO
BUILD YOUR TROLLEY ON
www.rocam.it





INOX VERSION >> pag. 50



 Buffet refrigerati con struttura in legno laminato o in acciaio inox. Calottina superiore abbassabile. Due portapiatti ribaltabili di serie. Vasca profonda 18 cm. con rubinetto di scarico. Refrigerazione statica gas R404a. Termostato digitale e lampada al neon. Due ruote con freno di serie.

 Refrigerated buffets, laminated wood structure or stainless steel structure. Upper sneezeguard can be closed manually. Two frontal tip-up dish-holders included. Well 18 cm. deep with drain cock. Static refrigeration of the well, gas R404a. Digital thermostat. Lighting with neon lamp. Two castors with brake included.

 Buffets réfrigérés avec structure en bois mélaminé ou complètement en acier inox. Calotte supérieure abaissable. Deux porte-assiettes rabattables sur les côtés principaux de série. Bac profonde 18 cm. avec robinet de vidange. Refroidissement statique gaz R404a. Thermostat numérique. Éclairage à neon. Deux roues à frein de série.

 Kühl-Bufferwagen aus melaminharzbeschichtetem Holz oder aus Edelstahl. Oberes Plexiglasdach kann manuell geschlossen werden. An beiden Längsseiten sind zusätzliche abklappbare Abstellflächen angebracht. Die Edelstahlwanne AISI 304 ist 18 cm tief und mit einem Ablasshahn ausgestattet. Die statische Kühlung der Wanne wird durch einen digitalen Thermostat geregelt. Zur Beleuchtung dient eine Neon-Leuchte. Inklusiv 4 Lenkrollen, davon 2 als Bremsrolle.

 Buffet refrigerados con estructura en madera laminada o totalmente en acero inoxidable. Tapa superior que se puede bajar manualmente. Dos portaplatos plegables incluidos. Cuba profunda 18 cm equipada con grifo de drenaje. Refrigeración estática, gas R404a. Termostato digital y lámpara de neón. Dos ruedas con freno incluidas.



EROS 5 R/L2

EROS 3 R/L2 GN H 150 1/1 1/1 1/1

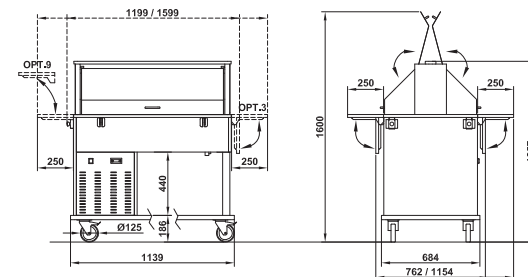

EROS 4 R/L2 GN H 150 1/1 1/1 1/1 1/1

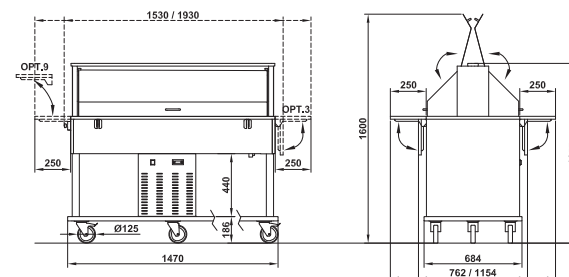

EROS 5 R/L2 GN H 150 1/1 1/1 1/1 1/1 1/1

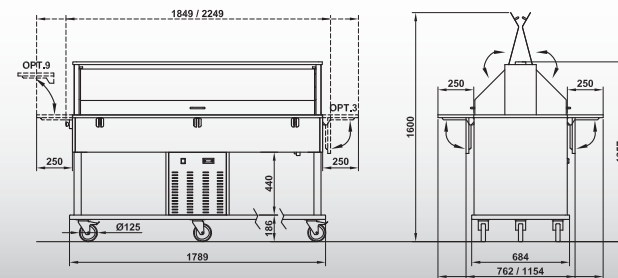

INOX VERSION >> pag. 50

OPTIONALS



OPT. 2



OPT. 3



OPT. 4



OPT. 5



OPT. 7



OPT. 8



OPT. 9



EROS 4 R/W

EROS 3 R/W GN H 150 1/1 1/1 1/1

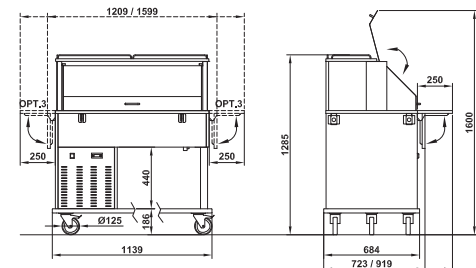

EROS 4 R/W GN H 150 1/1 1/1 1/1 1/1

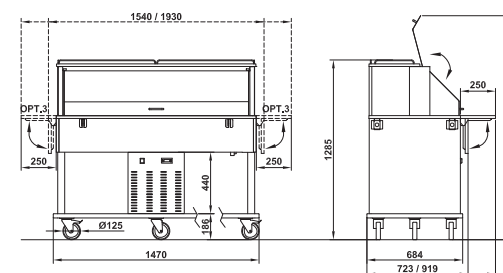

EROS 5 R/W GN H 150 1/1 1/1 1/1 1/1 1/1

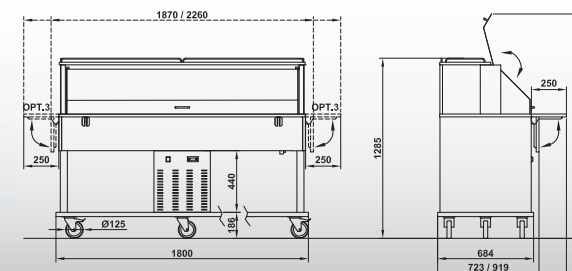

EROS	GN H 150	⚡ 230V max	OPTIONALS
EROS 3 R/L2	3 GN 1/1	349 W	2-3-4-5-7-8-9-GN
EROS 4 R/L2	4 GN 1/1	356 W	2-3-4-5-7-8-9-GN
EROS 5 R/L2	5 GN 1/1	356 W	2-3-4-5-7-8-9-GN
EROS 3 R/W	3 GN 1/1	349 W	2-3-4-5-7-GN
EROS 4 R/W	4 GN 1/1	356 W	2-3-4-5-7-GN
EROS 5 R/W	5 GN 1/1	356 W	2-3-4-5-7-GN



CONFIGURA IL TUO CARRELLO
BUILD YOUR TROLLEY ON
www.rocam.it



Buffet refrigerati con struttura in legno laminato o in acciaio inox. Portapiatti sul lato lungo e vasca inox AISI 304 con rubinetto di scarico. Refrigerazione statica con gas R404a, termostato digitale e illuminazione neon. 2 Ruote con freno di serie. EROS R/L2: dotato di calotta con doppi sportelli apribili ad ala di gabbiano e con sistema di frenata in discesa. EROS R/W: parte superiore chiusa da uno sportello con sistema di frenata in discesa e specchio sulla parete di fondo.



Refrigerated buffets, laminated wood structure or completely in st. steel. Dish-holder on the long side and st. steel AISI 304 well 18 cm deep. With drain cock. Static refrigeration with gas R404a, digital thermostat and neon lighting. 2 Castors with brake included. EROS R/L2: with double doors sneezeguard with gullwing opening and braking mechanism when closing down. EROS R/W: the upper part is closed by 1 door with braking mechanism when closing down. Mirror over the well.



Buffets réfrigérés avec structure en bois melaminé ou en inox. Porte-assiettes sur le côté long et bac en inox AISI 304 avec robinet de vidange. Refroidissement statique par gaz R404a, thermostat numérique et éclairage au néon. 2 Roulettes à frein de série. EROS R/L2: doté de calotte à 2 portes avec ouverture à gullwing et avec système de freinage en descente. EROS R/W: la partie supérieure est fermée par une porte avec système de freinage en descente et est doté d'un miroir sur la paroi arrière la bac.



Kühl-buffetwagen aus melaminharzbeschichtetem Holz oder aus Edelstahl. Die Hauben-Seiten lassen sich wie Flügel öffnen und verfügen beim Schließen der Haube über einen Bremsmechanismus. An Längsseite ist abklappbare Abstellfläche angebracht. Die AISI 304 Edelstahlwanne ist 18 cm. Tief und mit einem Ablasshahn ausgestattet. Die statische Kühlung der Wanne wird durch einen digitalen Thermostat geregelt. Zur Beleuchtung dient eine Neon-Leuchte. Inklusiv 4 Lenkrollen, davon 2 Bremsrolle.



Buffet refrigerados con estructura en madera laminada o totalmente en inox. Pote-platos al lado largo y cuba inox AISI 304 con grifo de descarga. Refrigeración estática con gas R404a, termostato digital y lampara de neón. 2 Ruedas con freno incluidas. EROS R/L2: dotado de tapa superior con doble abertura y sistema de frenado de descenso. EROS R/W: tapa superior cerrada con una puerta con sistema de frenado de descenso, espejo sobre la cuba.



EROS 3 BM



EROS 4 BM

EROS 3 BM GN H 150 1/1 1/1 1/1

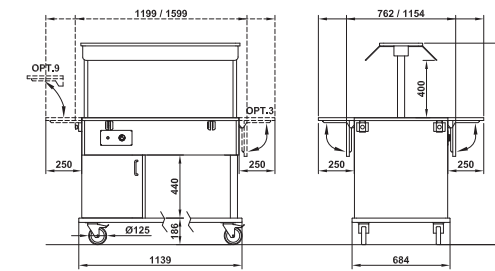

EROS 4 BM GN H 150 1/1 1/1 1/1

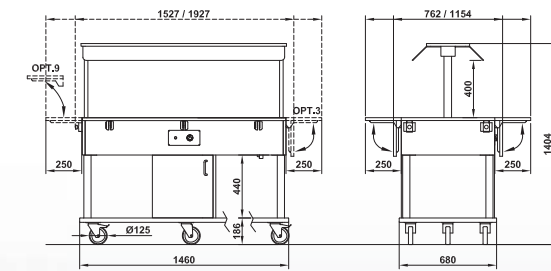

OPTIONALS





EROS 5 BM GN H 150 1/1 1/1 1/1 1/1 1/1

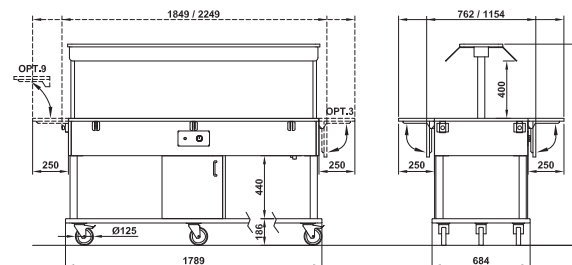

EROS	GN H 150	⚡ 230V _{max}	OPTIONALS
EROS 3 BM	3 GN 1/1	2271 W	1-2-3-4-7-8-9-GN
EROS 4 BM	4 GN 1/1	2278 W	1-2-3-4-7-8-9-GN
EROS 5 BM	5 GN 1/1	3028 W	1-2-3-4-7-8-9-GN
EROS 6 BM	6 GN 1/1	3042 W	1-2-3-4-7-8-9-GN



LBI	LFA	LNO	LWE	LCR	LTA
LPI	LAN	LSA	LNE	LRO	LNV

EROS 6 BM GN H 150 1/1 1/1 1/1 1/1 1/1 1/1

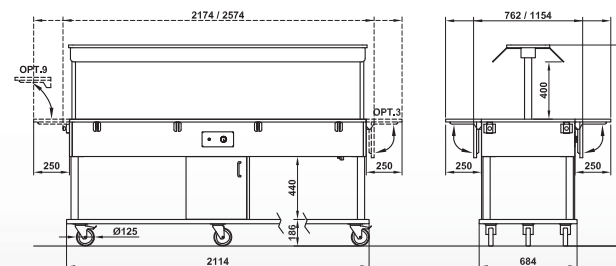

CONFIGURA IL TUO CARRELLO
BUILD YOUR TROLLEY ON
www.rocam.it

EROS 5 BM



Buffet riscaldati con struttura in legno laminato o in acciaio inox. Calottina superiore fissa. Due portapiatti ribaltabili lato servizio di serie. Vasca profonda 18 cm. con rubinetto di scarico. Riscaldamento a bagno maria con termostato meccanico (+30°/+90°C) e spia luminosa di funzionamento. Lampada al neon. Due ruote con freno di serie.



Heated buffets, laminated wood structure or stainless steel structure. Upper fixed sneeze-guard. Two frontal tip-up dish-holders included. Well 18 cm. deep with drain cock. Bain marie heating. Mechanical thermostat (+30°/+90°C) with indicator light. Lighting with neon lamp. Two castors with brake included.



Buffets chauffés avec structure en bois mélaminé ou complètement en acier inox. Calotte supérieure fixe. Deux porte-assiettes rabattables sur les côtés principaux de série. Bac profonde 18 cm. avec robinet de vidange. Chauffage à bain-marie et thermostat mécanique (+30°/+90°C) et voyant lumineux. Éclairage à neon. Deux roues à frein de série.



Bain Marie aus melaminharzbeschichtetem Holz oder aus Edelstahl AISI 304. Das Plexiglasdach ist fest montiert. Die AISI 304 Edelstahlwanne ist 18 cm tief und mit einem Ablasshahn ausgestattet. Bain-Marie wird mit einem unter der Wanne platzierten Heizelement beheizt. Temperatursteuerung durch einen mechanischen Thermostat (+30°/+90°C) mit Leuchtanzeige. Beleuchtung mit einer Neonlampe. 4 Lenkrollen, davon 2 Rollen mit Bremse enthalten.



Buffet calentados con estructura en madera laminada o totalmente en acero inoxidable. Tapa superior fija. 2 portaplatos plegables en el lado servicio incluidos. Cuba profunda 18 cm equipada con grifo de drenaje. Calentamiento baño maría, termostato mecánico (+30°/+90°C) y luz de encendido. Lámpara de neón. Dos ruedas con freno incluidas.

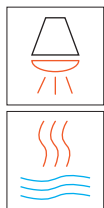

EROS 3 B/INFRA



EROS 4 B/INFRA

EROS 3 B/INFRA GN H 150 1/1 1/1 1/1

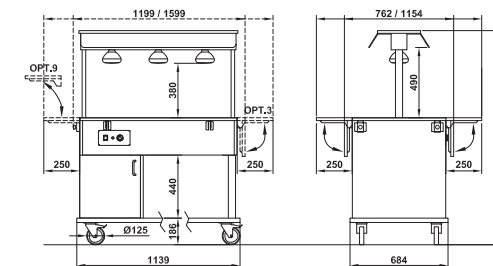

EROS 4 B/INFRA GN H 150 1/1 1/1 1/1 1/1

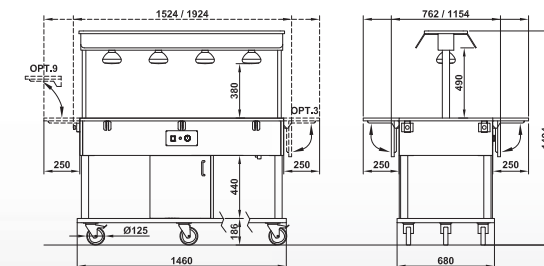

INOX VERSION >> pag. 52

OPTIONALS



OPT. 1



OPT. 2



OPT. 3



OPT. 4



OPT. 7



OPT. 8



OPT. 9



EROS 5 B/INFRA GN H 150 1/1 1/1 1/1 1/1 1/1

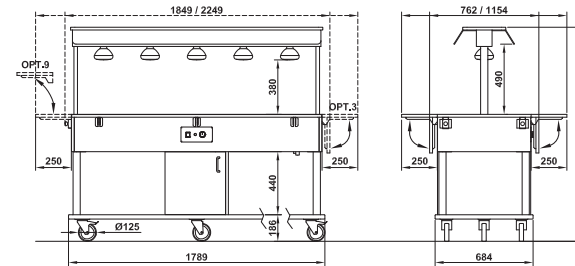

EROS	DIM.	⚡ 230V _{max}	OPTIONALS
EROS 3 B/INFRA	3 GN 1/1	3000 W	1-2-3-4-7-8-9-GN
EROS 4 B/INFRA	4 GN 1/1	3250 W	1-2-3-4-7-8-9-GN
EROS 5 B/INFRA	5 GN 1/1	4250 W	1-2-3-4-7-8-9-GN
EROS 6 B/INFRA	6 GN 1/1	4500 W	1-2-3-4-7-8-9-GN
EROS 3 S/INFRA	3 GN 1/1	3000 W	1-2-3-4-7-8-9-GN
EROS 4 S/INFRA	4 GN 1/1	3250 W	1-2-3-4-7-8-9-GN
EROS 5 S/INFRA	5 GN 1/1	4250 W	1-2-3-4-7-8-9-GN
EROS 6 S/INFRA	6 GN 1/1	4500 W	1-2-3-4-7-8-9-GN

EROS 6 B/INFRA GN H 150 1/1 1/1 1/1 1/1 1/1 1/1

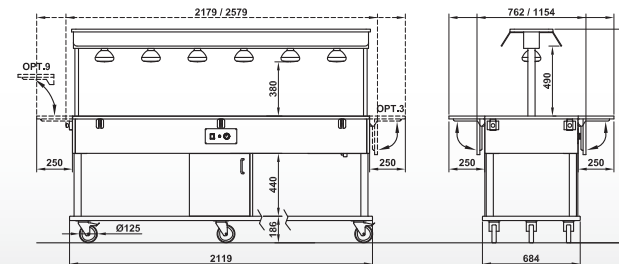

LBI	LFA	LNO	LWE	LCR	LTA
LPI	LAN	LSA	LNE	LRO	LNV

CONFIGURA IL TUO CARRELLO
BUILD YOUR TROLLEY ON
www.rocam.it

EROS 5 B/INFRA



Buffet riscaldati e con lampade infrarossi con struttura in legno laminato o in acciaio inox. Calottina superiore fissa. Due portapiatti ribaltabili lato servizio di serie. Vasca profonda 18 cm. con rubinetto di scarico. Riscaldamento a bagno maria con termostato meccanico (+30°/+90°C) e spia luminosa di funzionamento. Lampade ad accensione indipendente. Due ruote con freno di serie.



Heated buffets with infrared lamps, laminated wood structure or stainless steel structure. Upper fixed sneezeguard. Two frontal tip-up dish-holders included. Well 18 cm. deep with drain cock. Bain marie heating with mechanical thermostat (+30°/+90°C) with indicator light. Infrared lamps with independent lighting switch. Two castors with brake included.



Buffets chauffés et avec lampes à infrarouges, avec structure en bois melaminé ou complètement en acier inox. Calotte supérieure fixe. Deux porte-assiettes rabattables sur les côtés principaux de série. Bac profonde 18 cm. avec robinet de vidange. Chauffage à bain-marie et réglage de température par thermostat mécanique (+30°/+90°C) et voyant lumineux. Lampes avec interrupteur lumineux séparé. Deux roues à frein de série.



Bain Marie Buffetwagen mit Infrarotlampen aus melaminharzbeschichtetem Holz oder aus Edelstahl AISI 304. Das Plexiglasdach ist fest montiert.. Die Edelstahlwanne AISI 304 ist 18 cm tief und mit Ablasshahn ausgestattet. Bain Marie Beheizung mit Heizelementen unter der Wanne. Temperatursteuerung durch einen mechanischen Thermostat (+30°/+90°C) mit Leuchtanzeige. Die Infrarotlampen sind mit einem separatem Schalter ausgestattet. 4 Lenkrollen, davon 2 Rollen mit Bremse enthalten.



Buffet calentados con lámparas infrarrojos, estructura en madera laminada o totalmente en acero inoxidable. Tapa superior fija. 2 portaplatos plegables en el lado servicio incluidos. Cuba profunda 18 cm con grifo de drenaje. Calentamiento baño maría, termostato mecánico (+30°/+90°C) y luz de encendido. Lámparas infrarrojos con boton de encendido luminoso independiente. Dos ruedas con freno incluidas.

SPECIAL BUFFET

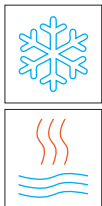

GN H 150 1/1 1/4 1/1 1/1

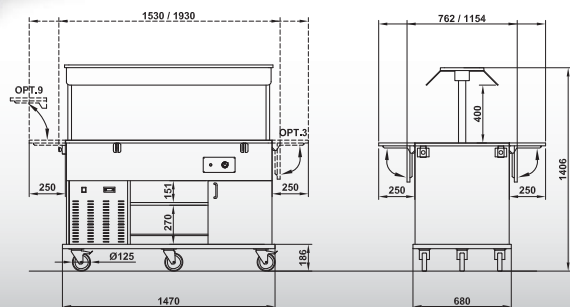

EROS MIX 4/1



GN H 150 GR 1/1 1/1 1/1

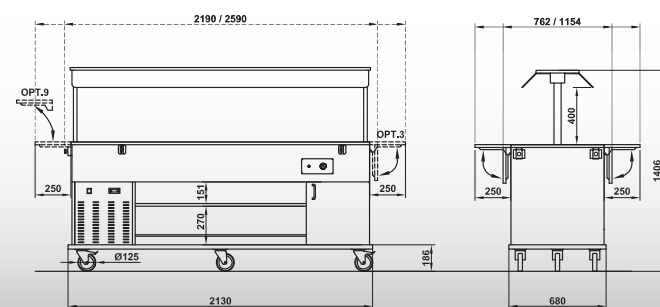

EROS MIX 6/1

OPTIONALS



OPT. 1



OPT. 3



OPT. 7



OPT. 8



OPT. 9



EROS BM/PLC 19
EROS BM/PLC 27

60 x Ø 19-26 cm
50 x Ø 27-33 cm

GN H 150 1/1 1/1

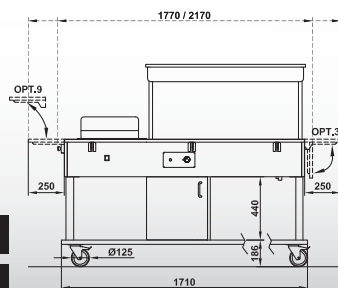

EROS ROLL TOP

GN H 65 1/1 1/1

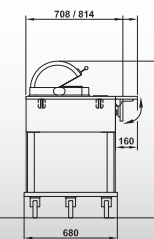
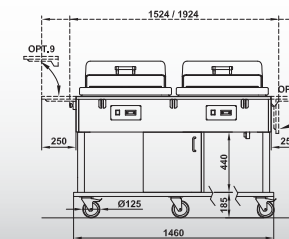
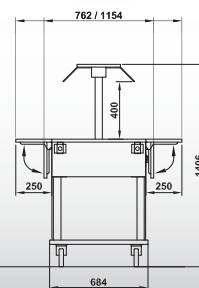

EROS	GN H 150	⚡ 230V max	OPTIONALS
EROS MIX 4/1	3 GN 1/1 + 1 GN 1/4	2221 W	1-2-3-4-7-8-9-GN
EROS MIX 6/1	1 GR + 3 GN 1/1	2278 W	1-2-3-4-7-8-9-GN
EROS BM/PLC 19 - 27	3 GN 1/1	2871 W	1-2-3-4-7-8-9-GN
EROS ROLL TOP	2 GN 1/1 - H 65	980 W	2-3-4-7



LBI	LFA	LNO	LWE	LCR	LTA
LPI	LAN	LSA	LNE	LRO	LNV

CONFIGURA IL TUO CARRELLO
BUILD YOUR TROLLEY ON
www.rocam.it



EROS MIX: buffet metà refrigerati e metà caldi. Struttura in legno laminato e cupola fissa. Portapiatti ribaltabili di serie. Vasche profonde di serie 18 cm con rubinetti di scarico separati. Refrigerazione statica gas R404a regolata da termostato digitale e griglia espositiva di serie. Parte riscaldata a bagnomaria con termostato meccanico (+30°/+90°) e spia di funzionamento. Lampada al neon e 2 ruote con freno di serie. EROS BM/PLC: combinazione di un buffet bagnomaria 3GN1/1 e un distributore piatti a livello costante riscaldato. EROS ROLL TOP: dotato di 2 scaldavivande a bagnomaria indipendenti 1GN1/1 incassati con cupola inox a scomparsa a 180° e arresto a 90°. Con 2 vaschette GN1/9 porta-posate.



EROS MIX: half refrigerated-half heated buffets. Laminated wood structure with upper fix sneezeguard. 2 Frontal tip-up dish holders included. Wells 18 cm. deep with 2 drain cocks. Static refrigeration gas R404a settled by a digital thermostat, cold well equipped by a s/steel grid. Bain-marie heated side settled by a mechanical thermostat (+30°/+90°) with indicator light. Neon lamp and 2 castors with brake. EROS BM/PLC: bain-marie heated buffet integrated with an heated plate dispenser equalizer. EROS ROLL TOP: equipped by 2 built-in chafing dishes 1GN1/1 with s/steel revolving lid up to 180° with stop at 90°. 2 GN-Pans 1/9 included.



EROS MIX: buffets combinés: une partie chauffée et une réfrigérée. Structure en bois mélaminé et coupole fixe. Porte-assiettes de série. Bacs profondes 18 cm. Avec 2 robinets de vidange séparés. Refroidissement statique gaz R404a réglé par thermostat numérique et grille inox de série. Partie chauffée à bain-marie avec thermostat mécanique (+30°/+90°) et voyant lumineux. Lampe au néon et 2 roulettes à frein de série. EROS BM/PLC: buffet à bain-marie 3GN1/1 combiné avec un distributeur d'assiettes à niveau constant chauffé. EROS ROLL TOP : doté de 2 chafing-dish 1GN1/1 encastrés, cloches inox avec ouverture à disparition à 180° avec blocage à 90°. 2 bacs 1/9 porte-couvertures incluses.



EROS MIX: Bain-marie und Kühlwagen aus melaminharzbeschichtetem Holz. Das Plexyglasdach ist fest montiert. Tellerhalterungen auf der Seiten. Wannen 18 cm. Tief mit separaten Ablasshahn. Die statische Kühlung der Wanne mit Gas R404a wird durch einen digitalen Thermostat geregelt, inklusive Edelstahlgitter. Bain-Marie wird mit einem Heizelement beheizt. Temperatursteuerung durch einen mechanischen Thermostat (+30°/+90°) mit Leuchtanzeige. Neonlampe und 2 Rollen mit Bremse. EROS BM/PLC: Bain-marie Buffetwagen mit einem beheizten Tellerspender. EROS ROLL TOP: mit 2 eingebauten Chafing-dish 1 GN1/1 mit einem runden Edelstahldeckel. Diese sind 180° versenkbar und haben einen Anschlag bei 90°. 2 GN-Behälter für Bestek.



EROS MIX: buffet mitad caliente y mitad frío. Estructura en madera laminada y tapa superior fija. Cubas profundas 18 cm. Con robinetes de descarga separados. Refrigeración estática gas R404a reglada por medio de un termostato digital, con rejilla de exposición incluida. Parte baño maria con termostato mecánico (+30°/+90°) y luz de encendido. Lampara neón y 2 redas con freno de serie. EROS BM/PLC: buffet baño maria 3GN1/1 combinado con un distribuidor de platos calentado a nivel constante. EROS ROLL TOP: equipados con 2 calentaplatos 1GN1/1 encajados en el mueble con tapa en acero inox escamoteable hasta 180° y parada a 90°. 2 Cubas 1/9 porta-cubiertos incluidas.

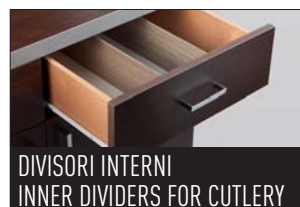

60 x Ø 19-26 cm

50 x Ø 27-33 cm

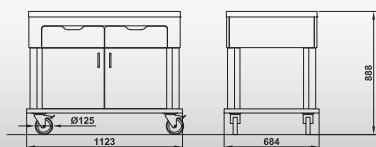

EROS SAL 2

EROS A2

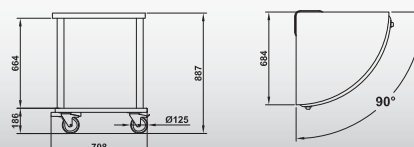

EROS PLC 19
EROS PLC 27

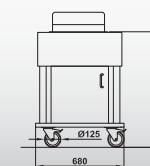

Buffet neutri per completare la linea self-service.
EROS SAL: dotato di due cassetti e di due vani con sportelli. Struttura in legno laminato, top in acciaio inox. EROS PLC: distributore di piatti a livello costante riscaldato con coperchio in plastica per piatti Ø19-26cm (PLC 19), o Ø27-33cm (PLC 27). Struttura in legno laminato. EROS A2: complemento utile per adattare la linea self service a spazi irregolari, piani in legno laminato. Due ruote con freno di serie.



Neutral buffet to completion of the self-service line.
EROS SAL: equipped with two drawers and two closed cupboards. Laminated wood structure. Stainless steel top. EROS PLC: heated plate dispenser equalizer equipped with plastic lid suitable for dishes with Ø19-26cm (PLC 19), or Ø27-33cm (PLC 27). Laminated wood structure. EROS A2: useful complement when an irregular self service line is required, laminated wood shelves. Two castors with brake included.



Buffet neutres pour compléter la ligne self-service.
EROS SAL: doté de deux tiroirs et de deux compartiments avec portes. Structure en bois melaminé, top en acier inox. EROS PLC: Distributeur d'assiettes à niveaux constant chauffé avec couvercle en plastique pour assiettes Ø19-26cm (PLC 19), ou Ø27-33cm (PLC 27). Structure en bois melaminé. EROS A2: complément pour adapter la ligne self-service à espaces irréguliers, étagères en bois melaminé. Deux roues à frein de série.



Neutraler Buffetwagen als Ergänzung der EROS Serie.
EROS SAL: aus melaminharzbeschichtetem Holz und Edelstahloberfläche AISI 304. Ausgestattet mit zwei Schubladen und zwei geschlossenen Schränken. EROS PLC: beheizter Tellerspender mit Kunststoffdeckel. Melaminharzbeschichtetes Holz. Geeignet für Teller mit einem Durchmesser von Ø19-26cm (PLC 19), oder Ø27-33cm (PLC 27). 4 Lenkrollen, davon 2 Bremsrollen. EROS A2: neutraler Eckwagen aus melaminharzbeschichtetem Holz nützlich mit unregelmäßiger Self-service Linie. Die sind mit 2 Rollen mit Bremsen ausgestattet.



Buffet neutros para completar la línea self-service.
EROS SAL: equipado con dos cajones y dos compartimentos con puertas. Estructura en madera laminada, top en acero inoxidable. EROS PLC: distribuidor de platos a nivel constante calentado y con tapa en plástico para platos Ø19-26cm (PLC 19), o Ø27-33cm (PLC 27). Estructura en madera laminada. EROS A2: complemento para adaptar la línea self-service a los espacios irregulares, estantes en madera laminada. Dos ruedas con freno incluidas.



EROS	⚡ 230V max
EROS SAL 2	-
EROS A2	-
EROS PLC 19-27	600 W
EROS PV	-
EROS TRP	-



CONFIGURA IL TUO CARRELLO
BUILD YOUR TROLLEY ON
www.rocami.it

EROS PV

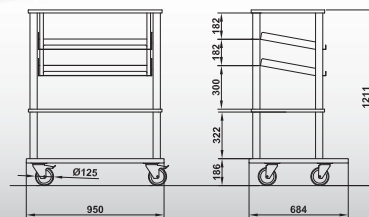

EROS TRP

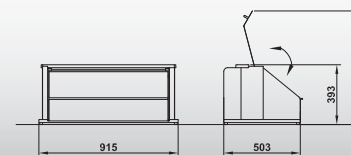

Complementi per la linea self-service.
EROS PV: elemento dotato di due piani inclinati in acciaio inox di capacità in larghezza di 4 vaschette da GN1/3. Due ruote con freno di serie. EROS TRP: tramoggia pane posizionabile sul top di EROS PV, con piano/griglia inclinato e asportabile in acciaio inox, sportello con sistema di frenata in discesa e teglia estraibile raccogli-briciole.



Self service line complements.
EROS PV: provided with two tilted stainless steel shelves, suitable for 4 GN1/3 pans. Two castors with brake included.
EROS TRP: bread box that can be placed on the top of EROS PV, equipped with a tilted removable shelf/grid in stainless steel, sneezeguard with frontal opening system with braking mechanism when closing down and extractable crumbs tray.



Compléments pour la ligne self-service.
EROS PV: élément doté de 2 étagères inclinés en acier inox qui peut porter 4 bacs GN1/3. Deux roues à frein de série.
EROS TRP: trémie à pain qui peut être positionnée sur le top du chariot EROS PV, dotée d'un étagère-grillé et amovible en acier inox, porte sur le côté principal avec système de freinage en descente et plateau à miettes amovible.



EROS PV: Schalen - Besteck - Gläser Station mit zwei schrägen Edelstahlregalen AISI 304. Geeignet für 4 GN 1/3 Behälter. Zwei Rollen mit Bremse enthalten. EROS TRP: Die Brot-Box kann ganz oben auf dem EROS PV platziert werden. Das Innengestell ist aus Edelstahl AISI 304. Die frontale Öffnung ist mit einem Brems-Schließ-Mechanismus ausgestattet.



Complementos para la línea self-service.
EROS PV: equipado con dos estantes inclinados en acero inoxidable con capacidad de ancho de 4 cubetas GN 1/3. Dos ruedas con freno incluidas. EROS TRP: tolva de pan aplicable arriba del EROS PV, con estante/rejilla inclinado y extraíble en acero inoxidable y puerta, con sistema de frenado por el cierre y bandeja extraíble para migas.

BUFFET REFRIGERATI INOX - STAINLESS STEEL REFRIGERATED BUFFET



EROS 3 R/M INOX

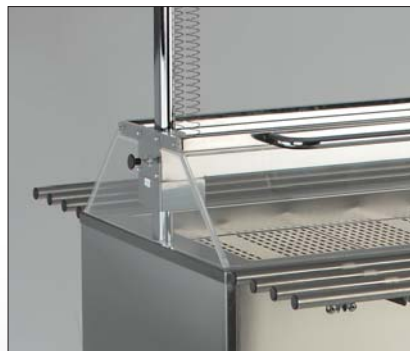

EROS 3 R/M GN H 150 1/1 1/1 1/1

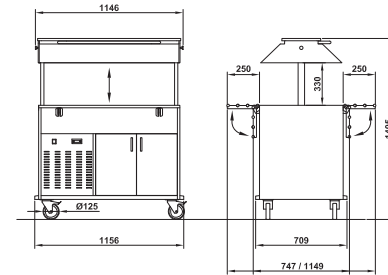

EROS 4 R/M GN H 150 1/1 1/1 1/1 1/1

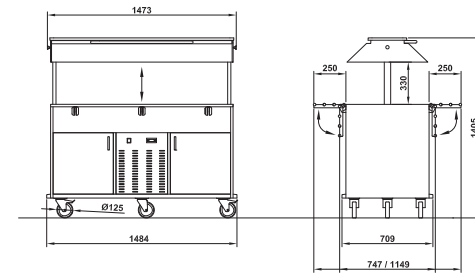

EROS 5 R/M GN H 150 1/1 1/1 1/1 1/1 1/1

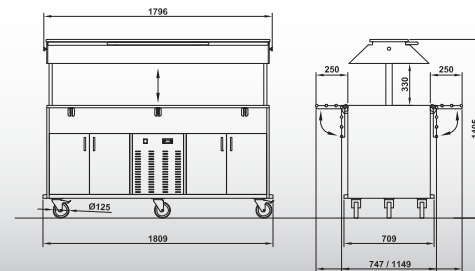

OPTIONALS





EROS 4 R/L2 INOX

EROS 3 R/L2 GN H 150 1/1 1/1 1/1

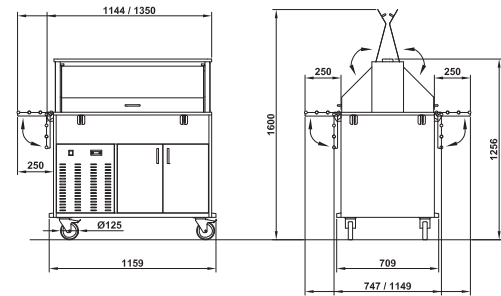

EROS 4 R/L2 GN H 150 1/1 1/1 1/1 1/1

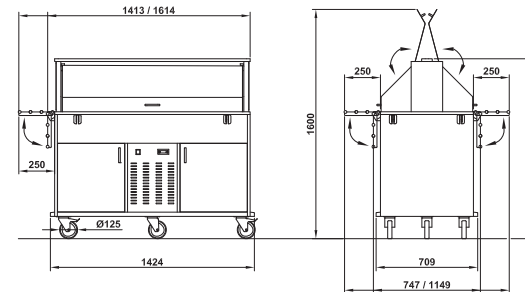

EROS 5 R/L2 GN H 150 1/1 1/1 1/1 1/1 1/1

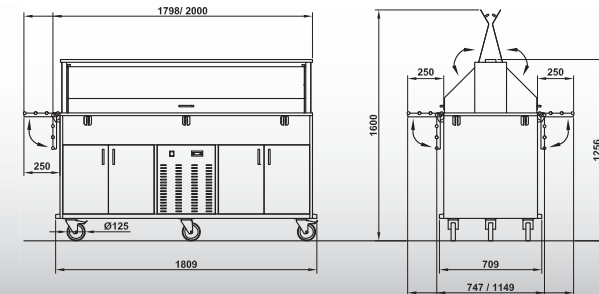

EROS INOX	GN H 150	⚡ 230V max	OPTIONALS
EROS 3 R/F	3 GN 1/1	349 W	4-5-8
EROS 4 R/F	4 GN 1/1	356 W	4-5-8
EROS 5 R/F	5 GN 1/1	356 W	4-5-8
EROS 3 R/M	3 GN 1/1	349 W	4-5-8
EROS 4 R/M	4 GN 1/1	356 W	4-5-8
EROS 5 R/M	5 GN 1/1	356 W	4-5-8
EROS 3 R/L2	3 GN 1/1	349 W	4-5-8
EROS 4 R/L2	4 GN 1/1	356 W	4-5-8
EROS 5 R/L2	5 GN 1/1	356 W	4-5-8

CONFIGURA IL TUO CARRELLO
BUILD YOUR TROLLEY ON
www.rocam.it



L'ampia gamma di buffet è disponibile – in alcune sue versioni – anche totalmente in acciaio inox AISI 304. La loro costruzione pertanto permette l'utilizzo in ambienti professionali che devono rispondere a precisi requisiti igienici come la facilità di pulizia, la resistenza all'umidità e alla salsedine. Scorri-vassoi in tubo ribaltabili e pratici paracolpi angolari, 2 ruote con freno di serie. La vasca è profonda 18 cm. ed è dotata di rubinetto di scarico. Refrigerazione statica con gas R404a e regolata da termostato digitale. Illuminazione a neon. EROS R/F: con calotta fissa. EROS R/M: con calotta mobile abbassabile meccanicamente. EROS R/L2: calottina con 2 sportelli apribili ad ali di gabbiano e sistema di frenata in discesa.



A wide range of buffets is also available, of which some are entirely made of AISI 304 stainless steel. These specific units can be used in professional environments where strict hygienic requirements as easy cleaning, great resistance to humidity and sturdiness are required. 2 Frontal pipe tip-up trays-holders, angular plastic bumper and 2 castors with brake included. The well is 18 cm. deep with drain cock. Static refrigeration with gas R404a and settled by a digital thermostat. Neon lamp. EROS R/F: fix sneezeguard. EROS R/M: the upper sneezeguard can be closed manually. EROS R/L2: Sneezeguard with gull wing opening system and braking mechanism when closing down.



Nous proposons une très large gamme de buffets dont certaines versions totalement en acier inox AISI 304. Une construction dédiée à une utilisation dans le milieu professionnel et répondant à des attentes hygiéniques strictes, facilitant le nettoyage, la résistance à l'humidité et au sel. Porte-plateaux rabattables en tube, pare-chocs angulaires en plastique et 2 roues à frein de série. La bacs est profonde 18 cm. et est dotée de robinet de vidange. Refroidissement statique par gaz R404a et réglé par thermostat numérique. Éclairage au néon. EROS R/F: avec pare-haleines fixe. EROS R/M: avec calotte mobile abaissable mécaniquement. EROS R/L2: vitrine à 2 portes avec ouverture à gullwing et système de freinage en descente.



In bestimmten Ausführungen ist die große Anzahl der Buffets auch ganz in Edelstahl AISI 304 erhältlich. Dies ermöglicht den professionellen Einsatz, wo höchsten Hygieneanforderungen, Stabilität und Widerstandsfähigkeit auch bei hoher Feuchtigkeit gefordert sind. An beiden Längsseiten sind abklappbare Abstellflächen angebracht. Inklusiven Eckigstoßschützen und 2 Rollen mit Bremse. Die Wanne ist 18 cm tief und ist mit einem Ablaufhahn ausgestattet. Die statische Kühlung der Wanne ist durch einen digitalen Thermostat geregelt. Zur Beleuchtung dient eine Neon-Leuchte. EROS R/F: Plexiglasdach fest montiert. EROS R/M: oberes Plexiglasdach kann manuell geschlossen werden. EROS R/L2: die Abdeckhaube verfügt über eine Bremsvorrichtung beim Schließen.



La amplia gama de buffet está disponible - en algunas de su versiones - también totalmente en acero inoxidable AISI 304. Por tanto, su construcción permite el uso en ambientes profesionales y que deben cumplir con los requisitos específicos, tales como la facilidad de limpieza, resistencia a la humedad y aire y sal. Escurre-bandejas en tubo plegable, para-golpes y 2 ruedas con freno incluidas. La cuba es profunda 18 cm. y equipada con grifo de drenaje. Refrigeración estática, gas R404a. Termóstato digital y lámpara de neón. EROS R/F: Cúpula fija. EROS R/M: tapa superior que se puede bajar manualmente. EROS R/L2: tapa superior con 2 puertas y abertura gullwing y sistema de frenado de descenso.

BUFFET INOX RISCALDATI - HEATED STAINLESS STEEL BUFFET



EROS 5 BM INOX

EROS 3 BM GN H 150 1/1 1/1 1/1

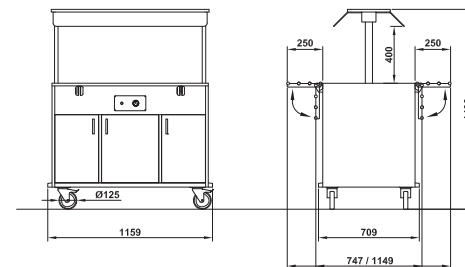

EROS 4 BM GN H 150 1/1 1/1 1/1 1/1

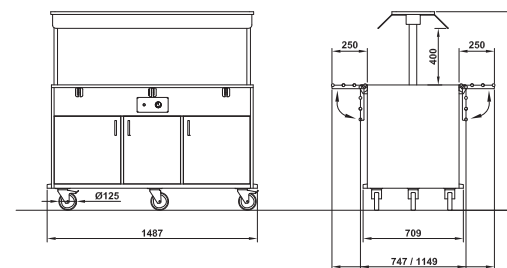

EROS 5 BM GN H 150 1/1 1/1 1/1 1/1 1/1

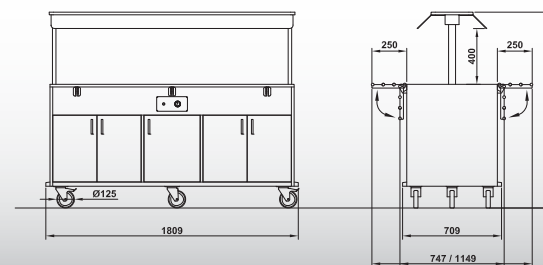

OPTIONALS





EROS 3 B/INFRA GN H 150 1/1 1/1 1/1

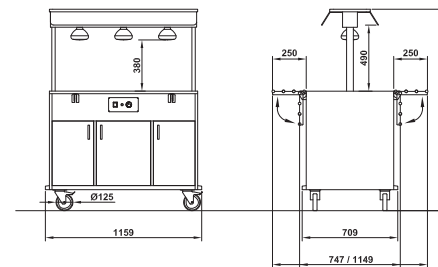

EROS 4 B/INFRA GN H 150 1/1 1/1 1/1 1/1

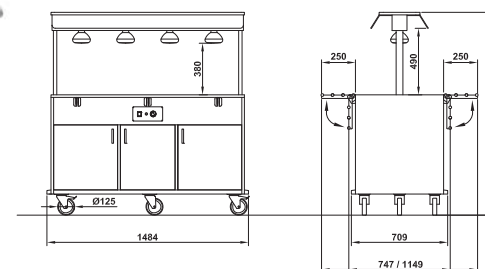

EROS 5 B/INFRA GN H 150 1/1 1/1 1/1 1/1 1/1

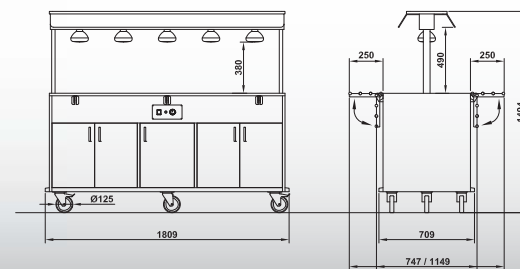

EROS INOX	GN H 150	⚡ 230V max	OPTIONALS
EROS 3 BM	3 GN 1/1	349 W	4-8
EROS 4 BM	4 GN 1/1	356 W	4-8
EROS 5 BM	5 GN 1/1	356 W	4-8
EROS 3 B/INFRA	3 GN 1/1	2850 W	4-8
EROS 4 B/INFRA	4 GN 1/1	3100 W	4-8
EROS 5 B/INFRA	5 GN 1/1	4050 W	4-8

CONFIGURA IL TUO CARRELLO
BUILD YOUR TROLLEY ON
www.rocam.it

EROS 4 B/INFRA INOX



L'ampia gamma di buffet è disponibile - in alcune sue versioni - anche totalmente in acciaio inox AISI 304. La loro costruzione pertanto permette l'utilizzo in ambienti professionali che devono rispondere a precisi requisiti igienici come la facilità di pulizia, la resistenza all'umidità e alla salsedine. Scorri-vassoi in tubo ribaltabili e pratici paracolpi angolari, 2 ruote con freno di serie. La vasca è profonda 18 cm. ed è dotata di rubinetto di scarico. Riscaldamento tramite resistenze regolato da termostato meccanico (+30°/+90°). EROS BM: con calotta fissa e con illuminazione neon. EROS B/INFRA: con calotta fissa e lampade a infrarossi.



A wide range of buffets is also available, of which some are entirely made of AISI 304 stainless steel. These specific units can be used in professional environments where strict hygienic requirements as easy cleaning, great resistance to humidity and sturdiness are required. 2 Frontal pipe tip-up trays-holders, angular plastic bumper and 2 castors with brake included. The well is 18 cm. deep with drain cock. Heated by electrical elements settled by a mechanical thermostat. EROS BM: Neon lamp and fix sneezeguard. EROS B/Infra with upper sneezeguard and infrared lamps.



Nous proposons une très large gamme de buffets dont certaines versions totalement en acier inox AISI 304. Une construction dédiée à une utilisation dans le milieu professionnel et répondant à des attentes hygiéniques strictes, facilitant le nettoyage, la résistance à l'humidité et au sel. Porte-plateaux rabattables en tube, pare-chocs angulaires en plastique et 2 roues à frein de série. La bac est profonde 18 cm. Et est dotée de robinet de vidange. Chauffage par éléments réglé par thermostat mécanique. EROS BM : éclairage au néon et avec pare-haleines fixe. EROS B/INFRA: avec calotte fixe et lampes à infrarouges.



In bestimmten Ausführungen ist die große Anzahl der Buffets auch ganz in Edelstahl AISI 304 erhältlich. Dies ermöglicht den professionellen Einsatz, wo höchsten Hygieneanforderungen, Stabilität und Widerstandsfähigkeit auch bei hoher Feuchtigkeit gefordert sind. An beiden Längsseiten sind abklappbare Abstellflächen angebracht. Inklusiven Eckigstoßschutten und 2 Rollen mit Bremse. Die Wanne ist 18 cm tief und ist mit einem Ablaufhahn ausgestattet. Die statische Kühlung der Wanne ist durch einen digitalen Thermostat geregelt. EROS BM: Zur Beleuchtung dient eine Neon-Leuchte und Plexiglasdach fest montiert. EROS B/INFRA: oberes Plexiglasdach fest montiert und Infrarotlampen.



La amplia gama de buffet está disponible - en algunas de su versiones - también totalmente en acero inoxidable AISI 304. Por tanto, su construcción permite el uso en ambientes profesionales y que deben cumplir con los requisitos específicos, tales como la facilidad de limpieza, resistencia a la humedad y aire y sal. Escurre-bandejas en tubo plegable, para-golpes y 2 ruedas con freno incluidas. La cuba es profunda 18 cm. y equipada con grifo de drenaje. Calentamiento con termostato mecánico. EROS BM: cúpula fija y lámpara de néon. EROS B/INFRA: tapa fija y lámpara infrarojos.



SERVICE TROLLEYS

Questa sezione è ciò da cui tutto è partito molti anni fa ed è tutt'ora la bandiera e l'orgoglio di Rocam: la collezione di carrelli di servizio per ristoranti. Ancora una volta siamo lieti di presentarvi una gamma rinnovata ed al passo con i tempi, qualsiasi sia lo stile o l'arredamento delle vostre sale troverete il carrello adatto.



This section is what Rocam is all about and where we started many years back, this is our flagship and our pride: our collection of service trolleys for restaurants. Once again we're pleased to present you a renewed and up to date range, whatever the style or the interior design of your dining halls you will find the suitable trolley.

Cette section présente le coeur de métier de Rocam, car c'est avec les chariots de service pour les restaurants que Rocam a commencé son activité il y a de nombreuses années. Une fois de plus, nous avons le plaisir de vous présenter une gamme renouvelée et à jour, indépendamment du style ou la décoration d'intérieur de vos salles à manger vous trouverez le chariot approprié.

Seit Firmengründung beschäftigt sich Rocam mit der Herstellung von Servicewagen für den Restaurantbereich. Voller Stolz können wir behaupten, dass unsere Servierwagen das Flaggschiff unserer Produkte darstellen und freuen uns, Ihnen hier unsere überarbeitete und ergänzte Kollektion zu präsentieren. Für jeden Stil werden Sie bei uns den passenden Wagen finden.

Desde su creación, Rocam se dedica a la fabricación de carros restaurante. Podemos decir con orgullo que nuestros carros representan el corazón de nuestros productos y estamos encantados de presentar una colección revisada y ampliada. Para cada estilo, usted encontrará el carro más adecuado.

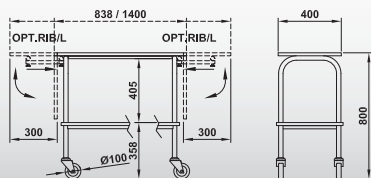

AURIGA VIP

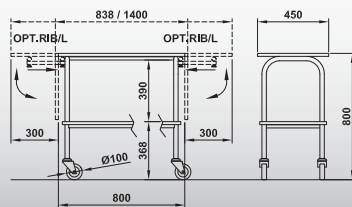

AURIGA T

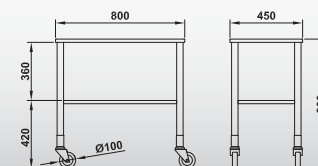

AURIGA Q 40

OPTIONALS

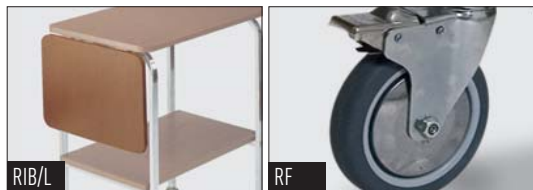



AURIGA	OPTIONALS
AURIGA Q40	RC-RF
AURIGA VIP	RIB/L-RC-RF
AURIGA VIP P5	RIB/L-RC-RF
AURIGA T	RIB/L-RC-RF
AURIGA T P5	RIB/L-RC-RF

AURIGA VIP
AURIGA T

AURIGA Q40

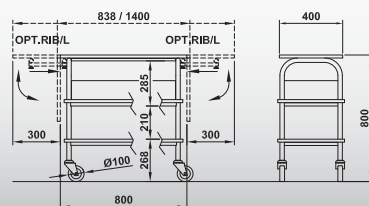

AURIGA VIP P5

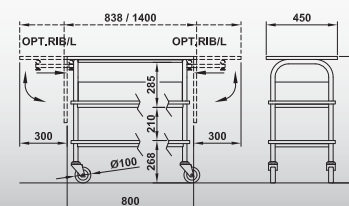

AURIGA T P5

CONFIGURA IL TUO CARRELLO
BUILD YOUR TROLLEY ON
www.rocam.it



Carrelli gueridon per il servizio ai tavoli, disponibili diversi modelli con struttura in tubo cromato tondo o quadro con ripiani in legno laminato color noce o con struttura completamente in legno massello lucidato noce (AURIGA Q40). 4 Ruote girevoli di serie, su richiesta 2 con freno (opt. RF).



Gueridon trolleys for table service, several models available, squared or rounded chromed tube structure with walnut laminated wood tiers or completely solid wood structure in walnut color (AURIGA Q40). 4 Swiveling castors included, 2 with brake on request (opt. RF).



Chariots gueridon pour le service à la table, disponibles nombreux modèles avec structure en tube chromé rond ou carré avec étagères en bois melaminé couleur noyer ou avec structure complètement en bois massif noyer (AURIGA Q40). 4 Roues pivotantes de série, sur demande 2 à frein (opt. RF).



Gueridon Wagen für den Service am Tisch. Mehrere Modelle zur Auswahl. Mit eckiger oder abgerundeter verchromter Rohrstruktur. Etagen aus melaminharzbeschichtetem Holz, in der Farbgebung Nussbaum. Das Modell AURIGA Q40 ist aus Massivholz und in der Farbe Nussbaum erhältlich. Inklusive 4 Lenkrollen, auf Anfrage 2 mit Bremse (Opt.RF).



Carros Gueridon para el servicio en sala, varios modelos disponibles con estructura en tubo redondo o cuadro cromado y estantes en laminado nogal o con estructura completamente en madera maciza acabada nogal (AURIGA Q40). 4 Ruedas giratorias incluidas, 2 ruedas con freno disponibles sobre pedido (opt. RF).

CROMATO - CHROMED STEEL

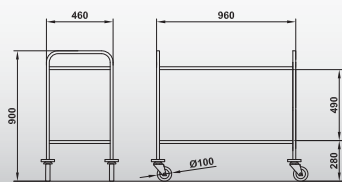

ALDEBARAN G2

CROMATO - CHROMED STEEL

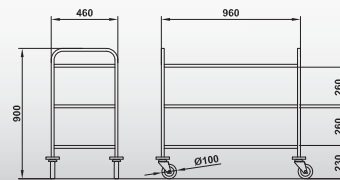

ALDEBARAN G3

ALDEBARAN P2

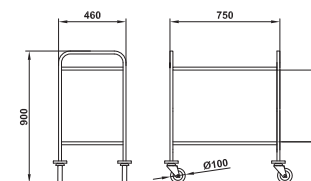

ALDEBARAN P3

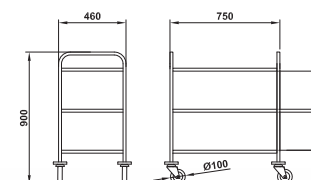

OPTIONALS



RF

INOX - STAINLESS STEEL



INOX - STAINLESS STEEL



ALDEBARAN	OPTIONALS
ALDEBARAN P2	RF
ALDEBARAN P3	RF
ALDEBARAN G2	RF
ALDEBARAN G3	RF
ALFA	RF
ALFA C/SP	RF
BETA	RF
BETA C/SP	RF



CONFIGURA IL TUO CARRELLO
BUILD YOUR TROLLEY ON
www.rocaml.it

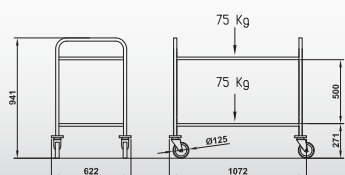

ALFA

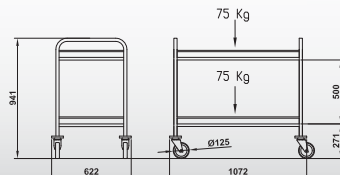

ALFA C/SP

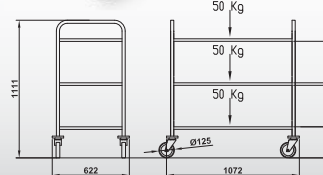

BETA

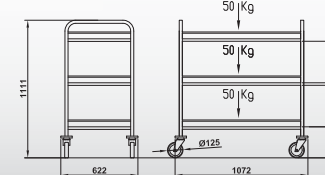

BETA C/SP



Carrelli per la sala a 2 o 3 piani con struttura in tubo quadro e ripiani in legno laminato color noce, con o senza spondine di contenimento. 4 Paracolpi antiraccia e 4 ruote girevoli di serie. Su richiesta 2 ruote con freno.



Service trolleys with 2 or 3 tiers, squared tube structure with walnut laminated wood shelves, with or without protection bars. 4 Non-marking bumpers and 4 swiveling castors included. On request 2 castors with brakes.



Chariots pour la salle à 2 ou 3 étagères avec structure en tube carré et étages en bois mélaminé couleur noyer, avec ou sans galeries de protection. 4 Pare-chocs anti-trace et 4 roues pivotantes de série. Sur demande 2 roues à frein.



Servierwagen mit 2 oder 3 Etagen. Vierkant-Rohre verchromt oder aus Edelstahl. Mit Etagen aus melaminharzbeschichtetem Holz, in der Farbgebung Nussbaum, mit oder ohne Schutzgalerien. Inklusive 4 Lenkrollen mit Stoßschutz aus Gummi. Auf Anfrage 2 Rollen mit Bremsen.



Carros para sala a 2 o 3 estantes, estructura en tubo cuadro y estantes en laminado nogal, sin o con barandillas de protección. 4 Paragolpes anti-rasguños y 4 ruedas giratorias incluidas. Sobre pedido 2 ruedas con freno.

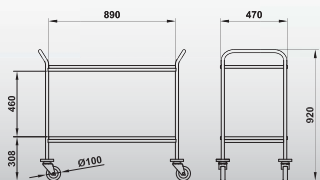

HIRA 500 M2

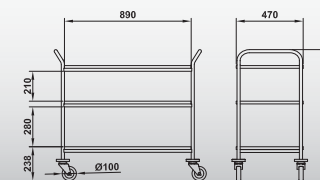

HIRA 500 M3

OPTIONALS





HIRA 500 M2 + PANDORA LE



HIRA	OPTIONALS
HIRA 500 M2	P3-PE/L-RF-S/H-P/LU
HIRA 500 M3	P3-PE/L-RF-S/H-P/LU
HIRA 600 M2	P3-PE/L-RF-S/H-P/LU
HIRA 600 M3	P3-PE/L-RF-S/H-P/LU
HIRA 600 G2	P3-PE/L-RF-S/H-P/LU
HIRA 600 G3	P3-PE/L-RF-S/H-P/LU



LBI	LFA	LNO	LWE	LCR	LTA
LPI	LAN	LSA	LNE	LRO	LNV

HIRA 600 M2

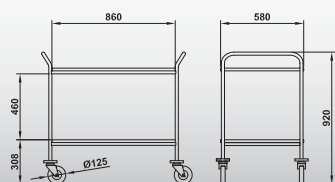

HIRA 600 M3

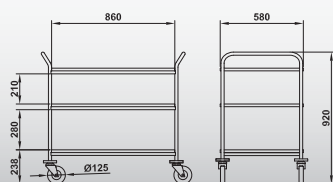

HIRA 600 G2

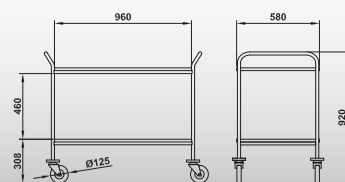

HIRA 600 G3

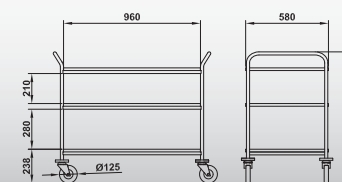

CONFIGURA IL TUO CARRELLO
BUILD YOUR TROLLEY ON
www.rocaml.it



Serie di carrelli per il servizio in sala a 2 o 3 ripiani. Struttura in tubo tondo cromato e ripiani in legno laminato con una vasta scelta di colori. Disponibili in 2 larghezze e in 2 lunghezze. 4 Paracolpi antitraçcia e 4 ruote girevoli di serie. Per il servizio di dolci e formaggi sono disponibili i modelli con cupola emisferica a doppia apertura (pag. 62). I carrelli possono essere arricchiti da dettagli in massello (Opt. P/LU) disponibili in 3 colori: MFA-Faggio, MNO-noce, MWE-wengé.



Range of service trolleys with 2 or 3 tiers. Rounded chromed tube structure and laminated wood tiers with a wide choice of colors. 2 Widths and 2 lengths available. 4 non-marking bumpers and 4 swiveling castors included. For the dessert and cheese service the trolleys with double opening hemispherical dome are available (page 62). Trolleys can be enriched by solid wood details (Opt. P/LU) available in 3 colors: MFA-hêtre, MNO-noyer, MWE-wengé.



Ligne de chariots pour le service en salle à 2 ou 3 étagères. Structure en tube rond chromé et étagères en bois mélaminé avec un vaste choix de couleurs. Disponibles en 2 largeurs et en 2 longueurs. 4 Parechocs anti-trace et 4 roues pivotantes de série. Pour le service de desserts et fromages les chariots avec une coupole hémisphérique à double ouverture sont disponibles (page 62). Les chariots peuvent être embellis par détails en bois massif (Opt. P/LU) dans les couleurs: MFA-hêtre, MNO-noyer, MWE-wengé.



Servierwagen mit 2 oder 3 Etagen. Abgerundete, verchromte Rohrstruktur mit melaminharzbeschichteten Holztagen in vielen Farben. Erhältlich in 2 Breiten und 2 Längen. Inklusive 4 Lenkrollen mit Abweisingen. Für den Dessert- und Käseservice sind die Wagen mit beidseitig zu öffnender, halbrunder Haube ausstattbar (S. 62). Auch können die Wagen mit zusätzlichen Massivholzapplikationen in den Farben Buche, Wenge und Walnuß aufgewertet werden (Opt. P/LU).



Selección de carros para el servicio en sala a 2 o 3 estantes. Estructura en tubo redondo cromado combinable con estantes disponibles en vario colores de laminado. Disponibles en 2 anchuras y 2 longitudes. 4 Paragolpes anti-rasguños y 4 ruedas giratorias incluidas. Para la presentación de postres y quesos los carros pueden tener una cúpula hemisférica a doble abertura (pag. 62). Los carros se pueden completar con detalles en madera maciza en color MFA-haya, MNO-nogal, MWE-wengé (Opt. P/LU).

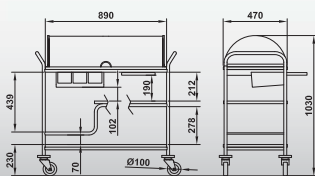

HIRA 500 MD2BL2

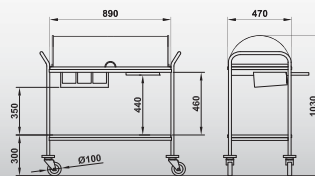

HIRA 500 MD2L2

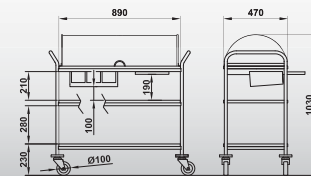

HIRA 500 MD3L2

OPTIONALS





HIRA 600 GD2L2

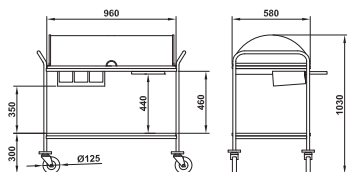

HIRA 600 GD3L2

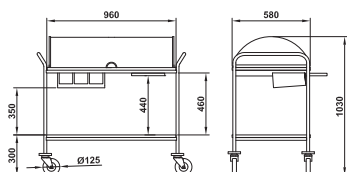

HIRA	GN H 150	⚡ 230V max	OPTIONALS
HIRA 500 MD2L2	-	-	P3-PE/L-RF-S/H-P/LU
HIRA 500 MD3L2	-	-	P3-PE/L-RF-S/H-P/LU
HIRA 600 GD2L2	-	-	P3-PE/L-RF-S/H-P/LU
HIRA 600 GD3L2	-	-	P3-PE/L-RF-S/H-P/LU
HIRA 500 MD2BL2	-	-	P3-PE/L-RF-S/H-P/LU
HIRA BM 2/1	2 GN 1/1	1500 W	GN-P/C-T/S
HIRA BM 3/1	3 GN 1/1	2250 W	GN-P/C-T/S



HIRA BM 3/1 GN H 150 1/1 1/1 1/1

HIRA BM 2/1 GN H 150 1/1 1/1

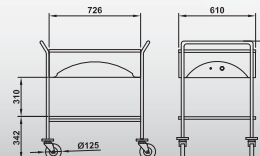
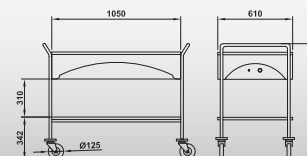

HIRA BM 3/1

CONFIGURA IL TUO CARRELLO
BUILD YOUR TROLLEY ON
www.rocam.it



Carrelli termici con struttura in tubo tondo cromato e rivestimento in legno laminato. 4 Paracolpi antiraccia e 2 ruote con freno di serie. Vasca profonda 16 cm. con rubinetto di scarico. Riscaldamento a bagno maria con termostato analogico (+30°/+90°C) e spia luminosa di funzionamento.



Bain Marie trolleys, rounded chromed tube structure with laminated wood paneling. 4 Non-marking bumpers and 2 castors with brake included. Well 16 cm. deep, equipped with drain cock. Bain marie heating with analogic thermostat (+30°/+90°C) with indicator light.



Chariots thermiques avec structure en tube rond chromé et revêtement en bois melaminé. 4 Pare-chocs antiraccie et 2 roues à frein de série. Bac profonde 16 cm. dotée de robinet de vidange. Chauffage à bain-marie avec thermostat mécanique (+30°/90°) et voyant lumineux de fonctionnement.



Bain Marie Wagen mit runder verchromter Rohrstruktur. Melaminharzbeschichtetes Holz in verschiedenen Farbgebungen. Serienmäßig bei allen Modellen sind 4 Lenkrollen, davon 2 als Bremsrolle und Stoßschutzringe aus Gummi. Modell Die Edelstahlwanne AISI 304 ist 16 cm tief und mit einem Ablasshahn ausgestattet. Die Heizelemente befinden sich unter dem Wassertank. Die Temperatur wird über ein analoges Thermostat (+30°/+90°C) geregelt.



Carros térmicos con estructura en tubo redondo cromado y revestimiento en madera laminada. 4 Parachoques anti-rasguños y 4 ruedas con freno incluidas. Cuba profunda 16 cm con grifo de descarga. Calefacción baño maría con termostato analógico (+30°/+90°C) y luz de encendido.

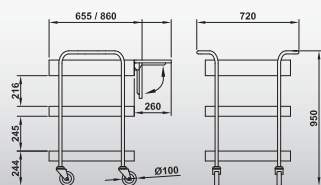

VENERE T/60

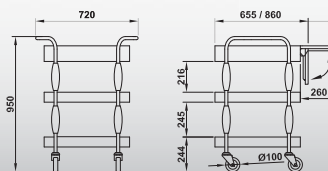

VENERE T/60 + P/LU

VENERE T/60 + PF

OPTIONALS



S/T

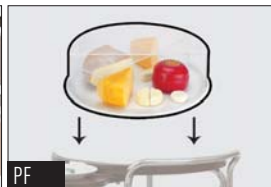

PF



CS



PM



RF



P/LU

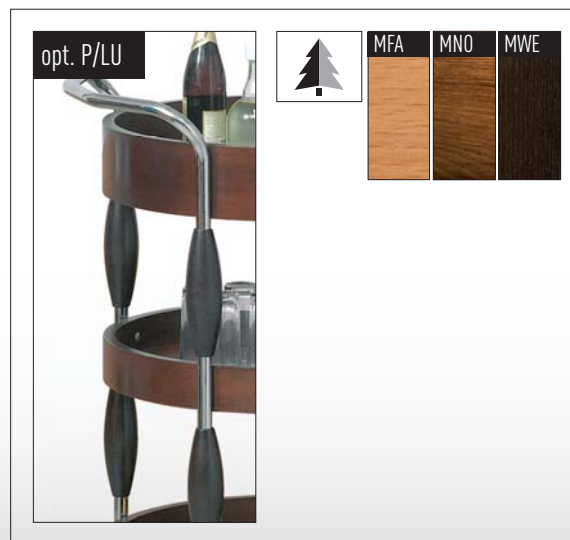

VENERE	OPTIONALS
VENERE T/60	PF-S/T-RF-P/LU
VENERE MF/60	CS-PM-S/T-RF



CONFIGURA IL TUO CARRELLO
BUILD YOUR TROLLEY ON
www.rocam.it

VENERE MF/60

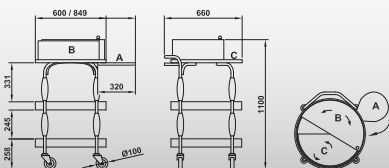

Carrelli per servizio ed esposizione di dolci, formaggi, vini e liquori. Struttura in tubo tondo cromato con ripiani in legno massello Ø60cm. 4 Ruote girevoli di serie. VENERE T: può essere completato da un piano espositivo asportabile con tagliere in PE alimentare e cupola girevole (opt. PF). Pianetto portapiatti ribaltabile. VENERE M: con particolari in legno massello sulla struttura cromata disponibili in 3 colori. Dotato di cupola e piano in PE alimentare girevole e asportabile. Pianetto portapiatti estraibile.



Desserts, cheese, wines and spirits service trolleys. Rounded chromed tube structure with solid wood tiers Ø60cm. 4 Swiveling castors included. VENERE T: can be completed by a removable food PE-chopping board and a revolving and removable dome (opt. PF). Capsizable dish holder included. VENERE M: equipped with solid wood details on the chromed legs available in 3 different colors. Completed with dome and with a hygienic PE revolving chopping board. Revolving dish-holder included.



Chariots pour le service et la présentation de fromages et desserts, vins et liqueurs. Structure en tube chromé avec étagères en bois massif Ø60cm. 4 Roues pivotantes de série. VENERE T: peut être complété par un étagère d'exposition amovible avec la planche à hacher en PE alimentaire et coupole tournante (opt. PF). Petit étagère porte-assiettes rabattable. VENERE M: avec détails en bois massif sur la structure chromée et disponibles en 3 couleurs. Doté de coupole et étagère en PE alimentaire tournant et amovible. Petit étagère porte-assiettes extractible.



Servicewagen zur Kuchen, Käse, Wein und Spirituosenpräsentation. Verchromte Struktur aus Rundrohr mit Massivholzetagen Ø60cm. Serienmäßig 4 Drehrollen. VENERE T: es kann durch eine Ausstellungsfläche mit herausnehmbarem PE Schneidbrett und einer Drehhaube ergänzt werden (opt. PF). Klappbare Tellerhalterfläche. VENERE M: es ist mit Massivholzdetaill auf der Chrom-Struktur bereichert, 3 Farben verfügbar. Mit Glocke und herausnehmbarer PE Drehfläche. Ausziehbarer Tellerhalter.



Carros para el servicio y la exposición de postres, quesos, vinos y licores. Estructura en tubo cromado redondo con estantes en madera maciza Ø60cm. 4 Ruedas giratorias incluidas. VENERE T: puede ser completado por una tabla de cortar de presentación en PE alimentar y una cúpula giratoria (opt PF.). Porte-plates abatible. VENERE M: con detalles en madera maciza sobre la estructura cromada, disponible en 3 colores. Completado por una cúpula y un estante en PE alimentar giratorio y extraíble. Estante portaplatos extraíble.

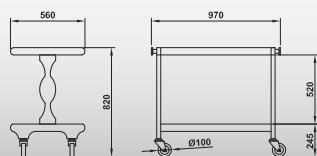

SCORPIONE 2

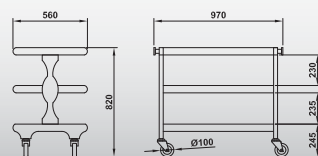

SCORPIONE 3

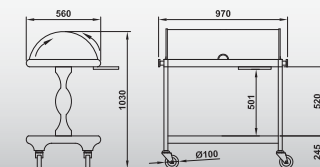

SCORPIONE D2L2

OPTIONALS



P3



PE/L



PG



SCORPIONE	OPTIONALS
SCORPIONE 2	P3-PE/L-PG
SCORPIONE 3	P3-PE/L-PG
SCORPIONE D2L2	P3-PG
SCORPIONE D3L2	P3-PG
SCORPIONE PB	PE/L-PG



CONFIGURA IL TUO CARRELLO
BUILD YOUR TROLLEY ON
www.rocam.it

SCORPIONE D3L2

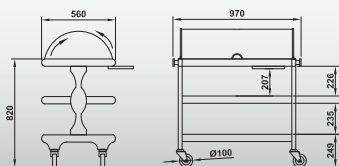

SCORPIONE PB

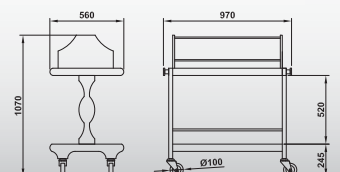

Carrelli in legno massello lucidato color noce a 2 o 3 ripiani con piani in legno laminato color noce. Modelli con cupola semisferica in plexiglass a doppia apertura (mod. D2L2 - D3L2) dotati di pianetto estraibile di serie. 4 Ruote girevoli di serie su tutti i modelli. Opt. PB per il servizio liquori.



Solid wood service trolleys in walnut colors with 2 or 3 tiers. Walnut laminated wood shelves. Models with hemispherical double opening plexiglass dome (mod. D2L2 - D3L2) equipped with sliding dish-holder. 4 swiveling castors included on all models. Opt. PB for liqueur services.



Chariots avec structure en bois massif couleur noyer à 2 ou 3 étagères en bois melaminé noyer. Les modèles avec coupole hémisphérique en plexy à double ouverture (mod. D2L2 - D3L2) ont de série un étagère porte-assiette escamotable. 4 Roues et pivotantes de série. Opt. PB pour le service liqueurs.



Massivholz Servierwagen in der Farbe Nussbaum mit 2 oder 3 Etagen. Modelle D2L2 und D3L2 sind mit einer halbrunden, beidseitig zu öffnenden Plexiglashaube und einer zusätzlich ausziehbaren Ablagefläche ausgestattet. Inklusive 4 mit Lenkrollen bei allen Modellen. Opt. PB zur Spirituosenpräsentation.



Carro en madera maciza y estantes en laminado, tinto nogal. Disponible con 2 o 3 estantes. Modelos con cúpola semiesférica en plexiglass con 2 aberturas (mod. D2L2 - D3L2) con plano extraíble incluido. Lleva de serie 4 ruedas giratorias. Opt. PB para l'exposició de las botellas.



MAIA 2

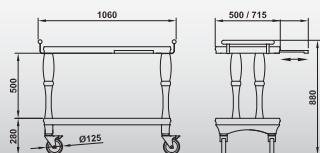

MAIA 3

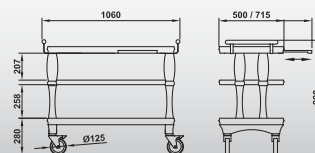

MAIA D2L2

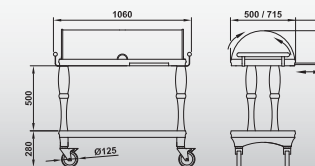

OPTIONALS



PB/M



RF



MAIA	OPTIONALS
MAIA 2	PB/M-RF
MAIA 3	PB/M-RF
MAIA D2L2	RF
MAIA D3L2	RF



CONFIGURA IL TUO CARRELLO
BUILD YOUR TROLLEY ON
www.rocaml.it

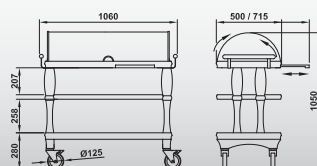

MAIA D3L2



Eleganti carrelli in legno massello a 2 o 3 ripiani disponibili in 3 colori, dotati di pianetto estraibile e 4 ruote girevoli di serie.



Stylish solid wood trolleys with 2 or 3 tiers, equipped with sliding dish-holder and 4 swiveling castors.



Éléphants chariots en bois massif à 2 ou 3 étagères disponibles en 3 couleurs, dotés de porte-assiettes escamotable et de 4 roues pivotantes de série.



Elegante Wagenlinie aus Massivholz mit serienmäßiger, zusätzlich ausziehbarer Ablagefläche. Inklusive 4 Lenkrollen.
3 verschiedenen Farben zur Auswahl.



Elegante línea de carros en madera maciza a 2 o 3 estantes disponible en 3 colores, con estante extraíble incluido.



MAIA REGAL

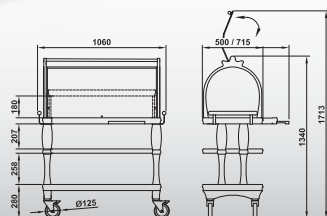

MAIA REF 3/1

GN H 150 1/1 1/1 1/1

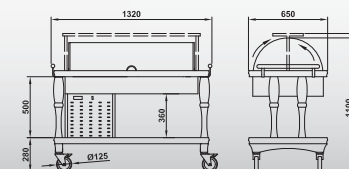

OPTIONALS



GN



GG/D GG/P

GG/D= GRIGLIA DOLCI - h 10 cm
DESSERT GRID - h 10 cm
GG/P= GRIGLIA PESCE - h 3 cm
FISH GRID - h 3 cm

* = Solo per mod. MAIA REF 3/1 - Only for mod. MAIA REF 3/1



MAIA	GN H 150	⚡ 230V _{max}	OPTIONALS
MAIA REGAL	-	-	-
MAIA REF EUT	-	-	-
MAIA REF 3/1	3 GN1/1	328 W	GN-GG/D-GG/P



CONFIGURA IL TUO CARRELLO
BUILD YOUR TROLLEY ON
www.rocam.it

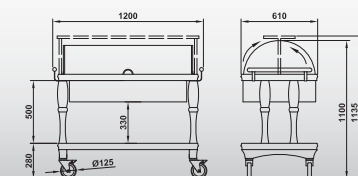

MAIA REF EUT



Carrelli refrigerati in legno massello disponibili in 3 colori, con cupola emisferica a doppia apertura. Vasca profonda 16 cm. con rubinetto di scarico. Refrigerazione statica gas R404a e termostato digitale (+2°/+8°C) (mod. REF 3/1) o tramite 2 piastre eutettiche (mod. REF EUT). Il modello REF EUT è fornito con griglia inossidabile di serie.



Refrigerated solid wood trolleys available in 3 colors with hemispherical double opening side dome. Well 16 cm. deep, equipped with drain cock. Static refrigeration of the well, gas R404a and digital thermostat (+2°/+8°C) (mod. REF 3/1) or with chilling packs (mod. REF EUT). REF EUT model is supplied with a display grid in series.



Chariots réfrigérés en bois massif disponibles en 3 couleurs, dotés de coupole hémisphérique à double ouverture. Bac profonde 16 cm. dotée de robinet de vidange. Refroidissement statique gaz R404a et thermostat numérique (+2°/+8°) (mod. REF EUT) ou refroidissement par plaques eutectiques (mod. REF EUT). Le modèle REF EUT est fourni avec une grille inox dans la bac de série.



Kühl-Servierwagen aus Massivholz in 3 Farbgebungen mit halbrunder, beidseitig zu öffnender Plexiglashaube. Die Edelstahlwanne AISI 304 ist 16 cm tief und mit einem Ablasshahn ausgestattet. Die Kühlung wird durch ein digitales Thermostat geregelt (+2°/+8°) (mod. REF 3/1) oder durch Kühlakkus in der Wanne platziert (mod. REF EUT). Das Modell REF EUT hat eine serienmäßige Edeltstahlgitter.



Carros refrigerados en madera maciza disponibles en 3 colores con cúpula semiesférica con doble apertura. Cuba profunda 16 cm con grifo de descarga. Refrigeración estática, gas R404a y termostato digital (+2°C/+8°C) (mod. REF 3/1) o por medio de placas eutéticas (mod. REF EUT). Modelo REF EUT lleva de serie rejilla inoxidable en la cuba.

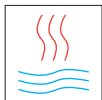

GN H 150 1/1 1/3 1/3

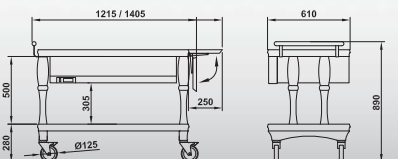

MAIA BM P



GN H 150 1/1 1/1 1/1

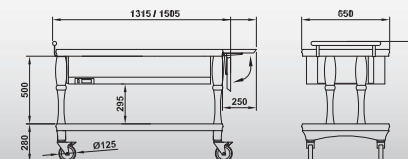

MAIA BM 3/1

OPTIONALS



GN

Vasche GN non incluse
GN pans are not included



MAIA BM 3/1



MAIA BM P



GN H 65 1/1

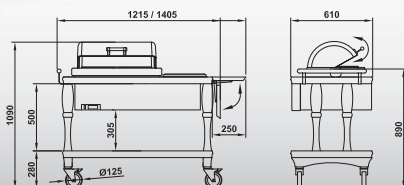

TAGLIERE MAGNETICO
MAGNETIC CHOPPING BOARD

MAIA	GN H 150	⚡ 230V max	OPTIONALS
MAIA BM P	1 GN 1/1 + 2 GN 1/3	1500 W	GN
MAIA BM 3/1	3 GN 1/1	2250 W	GN
MAIA BM VIP	1 GN 1/1 - H 65	490 W	-

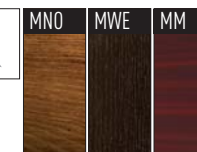

CONFIGURA IL TUO CARRELLO
BUILD YOUR TROLLEY ON
www.rocaml.it

MAIA BM VIP



Carrelli termici in legno massello disponibili in 3 colori con diverse capacità e completamente accessoriati (vasche GN non incluse). Vasca profonda 16 cm. con rubinetto di scarico. Riscaldamento a bagnomaria con termostato digitale.

MAIA BM VIP: con cupola in acciaio con apertura a scomparsa a 180°.



Thermic solid wood trolleys available in 3 different colors with different capacity and with many accessory included (GN pans not included). Well 16 cm. deep, equipped with drain cock. Bain marie heating with digital thermostat. MAIA BM VIP: Provided with a built-in chafing dish with 180° closure.



Chariots bain-marie en bois massif disponibles en 3 couleurs avec différentes capacités et complètement équipés (bacs GN pas incluses). Bac profonde 16 cm. dotée de robinet de vidange. Chauffage à bainmarie avec thermostat numérique.

MAIA BM VIP: doté d'une cloche en acier avec ouverture à disparition à 180°.



Bain Marie, Servier-Wagen aus Massivholz in 3 verschiedenen Farbgebungen. In verschiedenen Maßen und mit verschiedenstem Zubehör erhältlich (GN Pfannen sind nicht im Lieferumfang enthalten). Die Edelstahlwanne AISI 304 ist 16 cm tief und mit einem Ablasshahn ausgestattet. Die Bain- Marie Beheizung arbeitet mit Heizelementen, die unter der Wanne angebracht sind. Die Temperatur wird von einem digitalen Thermostat gesteuert.

Das Modell MAIA BM VIP ist mit einer um 180° versenkbaren Edelstahlhaube ausgestattet.



Carros térmicos completamente en madera maciza, disponibles en 3 colores y diferentes capacidades, totalmente equipados (cubas GN no incluidas). Cuba profunda 16 cm dotada de grifo de descarga. Calentamiento a baño maría con termostato digital.

MAIA BM VIP: equipado de cúpola en acero con abertura de 180° escamoteable.

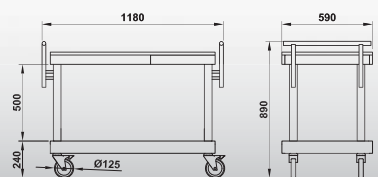

ARTEMIDE 2

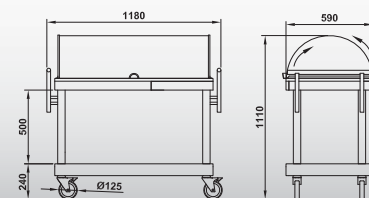

ARTEMIDE D2L2

OPTIONALS



RF



S/Q



ARTEMIDE	OPTIONALS
ARTEMIDE 2	S/Q-RF
ARTEMIDE D2L2	S/Q-RF
ARTEMIDE PB	-



CONFIGURA IL TUO CARRELLO
BUILD YOUR TROLLEY ON
www.rocam.it

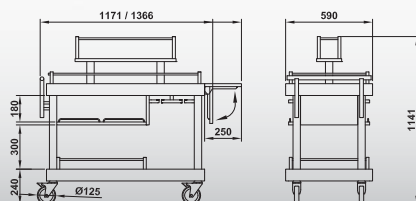

ARTEMIDE PB



Carrelli di servizio in acciaio inox e legno massello disponibili in 4 colori. Pianetto estraibile e 4 ruote girevoli di serie (mod. 2 - D2L2). ARTEMIDE PB: carrello liquori con rastrelliera per bicchieri e pianetto ribaltabile.



Stainless steel and solid wood service trolleys available in 4 colors. Sliding dish-holder and 4 swiveling castors included (mod. 2 - D2L2). ARTEMIDE PB: spirits trolley with glass rack and capsizable dish-holder.



Chariots de service en acier inox et bois massif disponibles en 4 couleurs. Étagère escamotable et 4 roues pivotantes de série (mod. 2 - D2L2). ARTEMIDE PB: chariot à liqueurs avec râtelier à verres et tablette rabattable.



Moderner Massivholz-Edelstahl Servierwagen in 4 verschiedenen Farben. Inklusive ausziehbarer zusätzlicher Ablagefläche und 4 Lenkrollen. Modell ARTEMIDE PB: Flaschenwagen mit versch. Halte-Relings für Gläser und Flaschen. Mit seitlich abklappbarer Ablagefläche ausgestattet. Inklusive 4 Lenkrollen.



Línea de carros para el servicio en madera maciza y acabado en acero inox disponible en 4 colores. Plano estraible y 4 ruedas giratoria incluidas (mod. 2 - D2L2). ARTEMIDE PB: carro para el servicio de licores con rejillas portavasos y plano plegable.



GN H 150 1/1 1/1 1/1

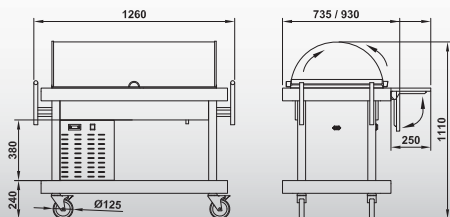

ARTEMIDE REF 3/1

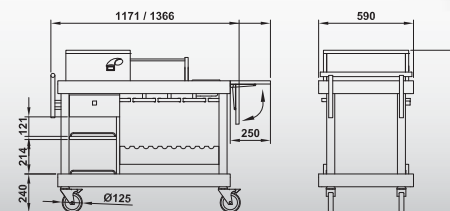

ARTEMIDE VINI

OPTIONALS



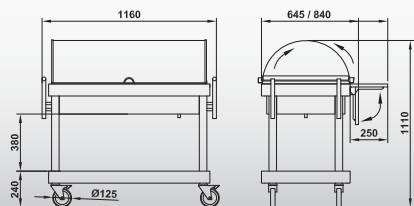

- GG/D= GRIGLIA DOLCI - h 10 cm
DESSERT GRID - h 10 cm
- GG/P= GRIGLIA PESCE - h 3 cm
FISH GRID - h 3 cm



ARTEMIDE REF EUT

 Carrelli refrigerati in legno massello dotati di cupola semisferica a doppia apertura. Vasca profonda 16 cm. con rubinetto di scarico. Refrigerazione statica gas R404a e termostato digitale (+2°/+8°C) (mod. REF 3/1) o tramite 2 piastre eutettiche (mod. REF EUT). Il modello REF EUT è fornito con griglia inox espositiva di serie. ARTEMIDE VINI: carrello vini con cassetto, rastrelliera per bicchieri, vaschetta porta turaccioli e pianetto ribaltabile. Con un compartimento refrigerato con piastre eutettiche per vini bianchi.

 Refrigerated solid wood trolleys available in 4 colors with hemispherical double opening side dome. Well 16 cm. deep, equipped with drain cock. Static refrigeration of the well, gas R404a and digital thermostat (+2°/+8°C) (mod. REF 3/1) or with chilling packs (mod. REF EUT). REF EUT model is supplied with a display grid in the well.. ARTEMIDE VINI: wine trolley with drawer, glass rack, cork-collection pan and capsizable dish-holder. Equipped with a chilling packs refrigerated compartment for white wines.

 Chariots réfrigérés en bois massif disponibles en 4 couleurs et doté de coupole hémisphérique à double ouverture. Bac profonde 16 cm. dotée de robinet de vidange. Refroidissement de la bac statique gaz R404a et thermostat numérique (+2°/+8°) (mod. REF 3/1) ou refroidissement par plaques eutectiques (mod. REF EUT). Le modèle REF EUT est fourni avec une grille inox dans la bac de série. ARTEMIDE VINI: chariot à vins avec tiroir, râtelier à verres, petite bac pour bouchons et tablette rabattable. Doté d'un compartiment réfrigéré par plaques eutectiques pour les vins blancs.

 Kühl-Servierwagen aus Massivholz-Edelstahl in 4 Farben mit einer halbrunden, beidseitig zu öffnender Plexiglashaube. Die Edelstahlwanne AISI 304 ist 16 cm tief und mit einem Ablasshahn ausgestattet. Die Kühlung der Wanne R404a wird durch einen digitalen Thermostat (+2°/+8°) (mod. REF 3/1) oder durch Kühlakkus in der Wanne platziert (mod. REF EUT). Das Modell REF EUT hat eine serienmäßige Edelstahlgitter. ARTEMIDE VINI: Wagen speziell für Wein und Sekt. Der Wagen ist mit einer Schublade, versch Halte-Relings für Gläser und Flaschen sowie einer seitlich abklappbaren Ablagefläche ausgestattet. Auf der oberen Etage befindet sich eine große Kühlbox/fach z.B. für Weißweine und Sekt.

 Carros refrigerados en madera maciza con cúpula semiesférica doble apertura. Cuba profunda 16 cm dotada de grifo de descarga. Refrigeración estática, gas R404a y termostato digital (+2°C/+8°C) (mod. REF 3/1) o por medio de placas eutécticas (mod. REF EUT). Modelo REF EUT lleva de serie rejilla inox en la cuba. ARTEMIDE VINI: carro para el servicio de vinos con cajón, rejillas portavasos, cubeta porta corchos, plano plegable y cajón refrigerado con placas eutécticas para los vinos blancos.



ARTEMIDE	GN H 150	⚡ 230V _{max}	OPTIONALS
ARTEMIDE REF EUT	-	-	GG/P-GG/D-SQ
ARTEMIDE REF 3/1	3 GN 1/1	328 W	SQ
ARTEMIDE VINI	-	-	-

ARTEMIDE





GN H 150 1/1 1/3 1/3

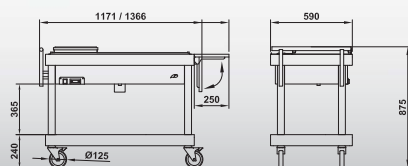

ARTEMIDE BM P



GN H 150 1/1 1/1 1/1

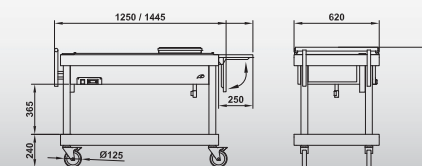

ARTEMIDE BM 3/1

OPTIONALS



GN



S/Q

Vasche GN non incluse
GN pans are not included



ARTEMIDE BM P



ARTEMIDE BM 3/1



GN H 65 1/1

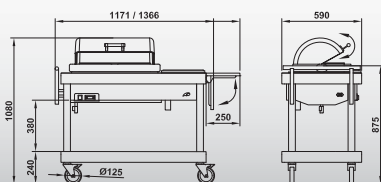

ARTEMIDE BM VIP



TAGLIERE MAGNETICO
MAGNETIC CHOPPING BOARD

ARTEMIDE	GN H 150	⚡ 230V max	OPTIONALS
ARTEMIDE BM P	1 GN 1/1 + 2 GN 1/3	1400 W	GN - SQ
ARTEMIDE BM 3/1	3 GN 1/1	2100 W	GN - SQ
ARTEMIDE BM VIP	1 GN 1/1 H 65	490 W	SQ



CONFIGURA IL TUO CARRELLO
BUILD YOUR TROLLEY ON
www.rocaml.it



Carrelli termici in legno massello con diverse capacità e completamente accessoriati (vasche GN non incluse). Vasca profonda 16 cm. con rubinetto di scarico. Riscaldamento a bagnomaria con termostato digitale. ARTEMIDE BM VIP: dotato di una cupola in acciaio con apertura a scomparsa a 180°.



Thermic solid wood trolleys with different capacity and with many accessories included (GN pans not included). Well 16 cm. deep, equipped with drain cock. Bain marie heating with digital thermostat. ARTEMIDE BM VIP: Provided with a built-in chafing dish with 180° closure.



Chariots bain-marie en bois massif disponibles avec différentes capacités et complètement équipés (bacs GN pas incluses). Bac profonde 16 cm. dotée de robinet de vidange. Chauffage à bainmarie avec thermostat numérique. MAIA BM VIP: doté d'une cloche en acier avec ouverture à disparition à 180°.



Bain Marie-Servierwagen aus Massivholz-Edelstahl in 4 Farbgebungen. In verschiedenen Maßen und mit verschiedenem Zubehör erhältlich (GN Behälter sind nicht im Lieferumfang enthalten). Das Modell ARTEMIDE BM VIP ist mit einer eingebauten Wärmewanne und einer um 180° versenkbaren Edelstahl-Haube ausgestattet.



Carros térmicos en madera maciza, con diferentes capacidades y totalmente equipado (cubas GN no incluidas). Cuba profunda 16 cm. dotada de grifo de descarga. Calentamiento a baño maría con termostato digital. ARTEMIDE BM VIP: equipado de cúpula en acero con abertura de 180° escamoteable.

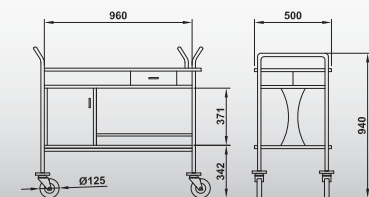

HIRA F/1

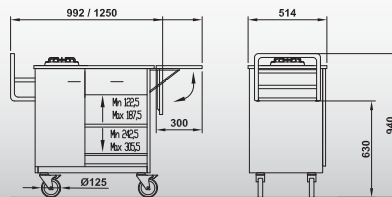

MERCURIO F/1

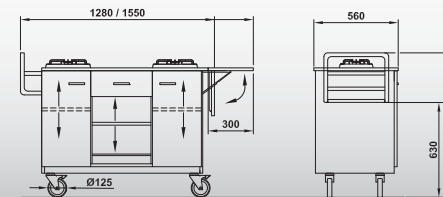

MERCURIO G/1 + 1

MERCURIO G1+1 - ARTEMIDE F/1

N°	BRUCIATORI BURNER	GAS	PRESSIONE PRESSURE	PORTATA TERMICA HEAT INPUT	UGELLO NOZZLE	PORTATA TERMICA W HEAT INPUT W
1	TRIPLA CORONA TRIPLE CROWN	G30-BUTANE	28-30 mbar	244 g/h	Ø 93 mm	MIN 1400 - MAX 3350
1		G 31 PROPANE	37 mbar	239 g/h	Ø 93 mm	MIN 1400 - MAX 3350

HIRA F/1 - MERCURIO F/1 - MAIA F/1

N°	BRUCIATORI BURNER	GAS	PRESSIONE PRESSURE	PORTATA TERMICA HEAT INPUT	UGELLO NOZZLE	PORTATA TERMICA W HEAT INPUT W
1	MEDIO SEMI-RAPIDO	G30-BUTANE	30 mbar	127 g/h	Ø 65 mm	MIN 450 - MAX 1750
1	MEDIUM SEMI-RAPID	G 31 PROPANE	37 mbar	127 g/h	Ø 65 mm	MIN 450 - MAX 1750



	OPTIONALS
HIRA F/1	-
MERCURIO F/1	-
MERCURIO G/1	-
MAIA F/1	-
ARTEMIDE F/1	

MAIA - ARTEMIDE



HIRA - MERCURIO

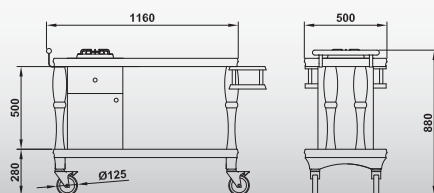

MAIA F/1

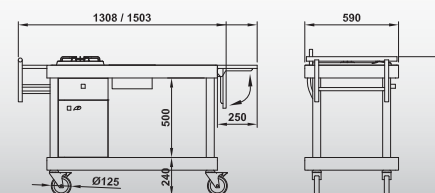

ARTEMIDE F/1



Le varie linee di carrelli sono completate anche dalla versione flambé a 1 o 2 fuochi. A seconda del modello sono prodotti in legno massello o legno laminato e sono tutti dotati di un comodo portabottiglie, un cassetto e vano porta bombola. Funzionamento a gas butano o propano, la bombola gas non è inclusa.



Our trolleys lines are completed by the flambé version with 1 or 2 burners. According to the model they are manufactured in solid or laminated wood and each model has a convenient bottle-holder, a drawer and gas bottle cabinets. Working with butane or propane gas tank, not included.



Nous vous proposons également nos chariots pour flambé à 1 ou 2 feux. Selon le modèle ils sont produits en bois massif ou en bois mélaminé et tous sont dotés d'un porte-bouteilles, un tiroir et un espace porte bouteille à gaz. Fonctionnement avec gaz butane ou propane, bouteille à gaz non incluse.



Unsere Wagenmodelle können auch zu ein- oder zweiflammigen Flambierwagen erweitert werden. Modellabhängig werden sie mit Massivholz oder melaminharzbeschichtetem Holz angeboten und sind jeweils mit praktischem Flaschenhalter, einer Schublade und einem sicheren Gasflaschenplatz ausgestattet. Zu betreiben mit Propan- oder Butangas (nicht enthalten).



Las diferentes líneas de carros se complementan también con la versión flambé con 1 o 2 hornillos. Según el modelo, los carros son fabricados en madera maciza o laminada y están equipados con porte-botellas, una cajón y un compartimiento para el cilindro de gas. Funcionamiento con gas butano o propano, la bombona de gas no está incluida.

CARRELLO REFRIGERATO - REFRIGERATED TROLLEY



GN H 150 1/1 1/1 1/1

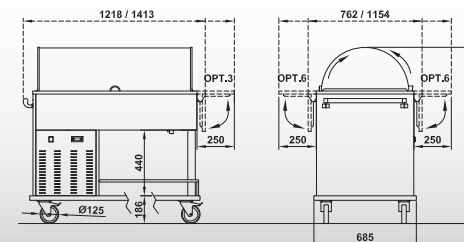

ZEUS

OPTIONALS



GG/D= GRIGLIA DOLCI - h 10 cm
 DESSERT GRID - h 10 cm
 GG/P= GRIGLIA PESCE - h 3 cm
 FISH GRID - h 3 cm



ZEUS	GN H 200	⚡ 230V max	OPTIONALS
ZEUS	3 GN 1/1	328 W	3-4-6-GG/P-GG/D-GN

	LBI	LFA	LNO	LWE	LCR	LTA
	LPI	LAN	LSA	LNE	LRO	LNV

CONFIGURA IL TUO CARRELLO
BUILD YOUR TROLLEY ON
www.rocam.it



Carrello refrigerato con struttura in legno laminato. Cupola emisferica a doppia apertura. Vasca profonda 18 cm. con rubinetto di scarico. Refrigerazione statica gas R404a. Termostato digitale (+2°/+8°C). Maniglia di spinta e due ruote con freno di serie.



Refrigerated trolley, laminated wood structure. Hemispherical double opening side dome. Well 18 cm. deep, equipped with drain cock. Static refrigeration of the well, gas R404a. Digital thermostat (+2°/+8°C). Pushing handle and 2 castors with brake included.



Chariot réfrigérée avec structure en bois mélaminé. Coupole hémisphérique à double ouverture. Bac profonde 18 cm. dotée de robinet de vidange. Refroidissement statique gaz R404a. Thermostat numérique (+2°/+8°C). Poignée de poussée et 2 roues à frein de série.



Kühl-Serviewagen aus melaminharzbeschichtetem Holz. Auswahl an verschiedenen Farben und Zubehör. Die halbrunde hemisphärische Plexiglashaube lässt sich von beiden Seiten öffnen. Die Edelstahlwanne AISI 304 ist 18 cm tief und mit einem Ablasshahn ausgestattet. Statische Kühlung der Wanne. Die Temperatur wird digital gesteuert und geregelt.



Carro refrigerado con estructura en madera laminada. Cúpula semiesférica en Plexiglass con doble abertura. Cuba profunda 18 cm equipada con grifo de drenaje. Refrigeración estática gas R404a. Termostato digital (+2°/+8°C). Manija de empuje y 2 ruedas con freno incluidas.

VETRINE ESPOSITIVE REFRIGERATE - REFRIGERATED DISPLAY CASES



GN H 20 1/1 1/1 1/1

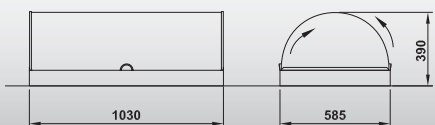

PANDORA 3/1



PANDORA LE

OPTIONALS



GN



GG/D GG/P



KIT AGGIUNTIVO PER
MAGGIOR AUTONOMIA
ADDITIONAL KIT FOR
A LONGER SERVICE



HIRA 500 M2 + PANDORA LE



PANDORA	OPTIONALS
PANDORA 3/1	GG-GN (H 20 mm)
PANDORA REF LE GL2	-
PANDORA REF GL2	-



LBI	LFA	LNO	LWE	LCR	LTA
LPI	LAN	LSA	LNE	LRO	LNV

PANDORA INOX



Vitrine espositiva per antipasti, dolci e formaggi. Disponibili in 2 dimensioni con cupola emisferica a doppia apertura. L'espositore può essere neutro o refrigerato tramite piastre eutettiche. Le versioni refrigerate mantengono il freddo fino a 5 ore. Le piastre eutettiche sono di serie e possono essere integrate da set supplementari per l'uso prolungato dell'apparecchio.



Showcases for hors d'oeuvres, cheese and desserts. Available in 2 dimensions, with double opening hemispherical dome. The appliance can be neutral or refrigerated by eutectic plates. The st. steel isolated double wall tank keeps low temperatures up to 5 hours. Eutectic plates included, additional sets can be added for a longer use.



Vitrines pour la présentation de fromages, hors d'oeuvres et desserts. Disponibles en 2 dimensions avec coupole hémisphérique à 2 ouvertures. L'expositeur peut être neutre ou réfrigéré par plaques eutectiques. La bac en acier inox à double paroi isolée maintiens le froid jusqu'à 5 heures. Les plaques eutectiques sont incluses mais la vitrine peut être complétée par set supplémentaires pour l'usage prolongé.



Kühlvitrinen für hors d'oeuvres, Käse und Desserts. Kühlfunktion durch Kühlakkus. Erhältlich in 2 Größen mit einer runden, beidseitig zu öffnenden Plexiglashaube. Die zur Verfügung gestellten Kühlakkus kühlen bis zu 5 Stunden. Einen längeren Kühleffekt erhalten Sie durch den Einsatz von zusätzlichen Eutecticplatten. Modell PANDORA REF GL2 ist komplett aus Edelstahl AISI 304.



Vitrina expositora para tapas postres y quesos. Disponible en 2 dimensiones, equipada de cúpula semiésferica con 2 aberturas y 2 estantes. Neutra o refrigerada mediante placas eutéticas. En la version refrigerada es posible conservar "frescos" los alimentos por 5 horas gracias a la cuba en acero inox a doble pared completamente aislada. Placas eutéticas de serie, sobre pedido kit suplementario de placas por el uso prolongado del aparato.



WAITER STATIONS

Ampia gamma di mobili di servizio per la sala ristorante. La nostra proposta si compone di 3 linee di mobili in legno laminato e una vasta gamma di colori. I loro stili differenti e i numerosi modelli permettono di rispondere a tutte le esigenze del servizio in sala. Per agevolare il servizio all'esterno è disponibile anche un modello, totalmente innovativo, in acciaio inox.



Wide range of waiter stations for restaurants. Our offer is composed of three lines of laminated wooden dumbwaiters and a wide range of colors. Their different styles and several models allow us to answer to each need of the restaurant hall service. To facilitate the service outside is also available a new model completely in stainless steel.

Large gamme de vaisseliers pour la salle restaurant. Notre société offre trois lignes de meubles en bois melaminé et une large gamme de couleurs. Leurs styles différents et les nombreux modèles nous permettent de répondre à toutes exigences du service en salle. Pour faciliter le service au dehors, est disponible un nouveau modèle entièrement en acier inoxydable.

Vielen Modelle von Service Board für den Restaurantsaal. Unser Unternehmen bietet drei Linien aus melaminharzbeschichtetem Holz mit einer breiten Farbpalette. Mehrere Modelle beantworten an alle Bedürfnisse der Restaurantsaal. Für den Außenservice gibt es auch ein neues Modell komplett aus Edelstahl.

Amplia gama de muebles para el servicio en los restaurantes. Nuestra empresa ofrece tres líneas de muebles en madera laminada y una amplia gama de colores. Sus diferentes estilos y los varios modelos nos permiten responder a todas las necesidades del servicio en la sala. Para facilitar el servicio al exterior hay también un modelo completamente nuevo en acero inoxidable.



AL KOR 2 AP



AL KOR 2 AP B/R



PP/F



TR

AL KOR 2 AP

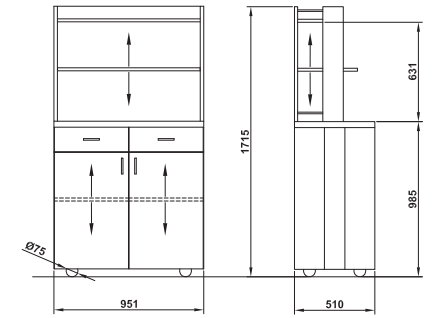

AL KOR 2 AP B/R

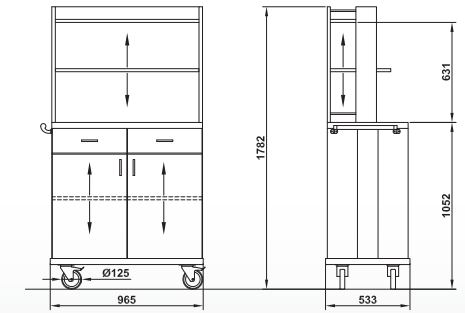

OPTIONALS



PP/F

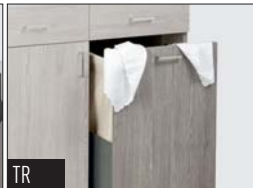

TR

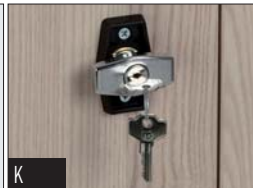

K

TUTTI I MOBILI SONO SU RUOTE.
ALL DUMBWAITERS ARE ON CASTORS.





ALKOR 2 CH



ALKOR 2 CH B/R

ALKOR 2 CH

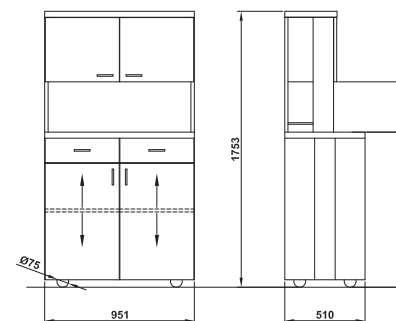

ALKOR 2 CH B/R

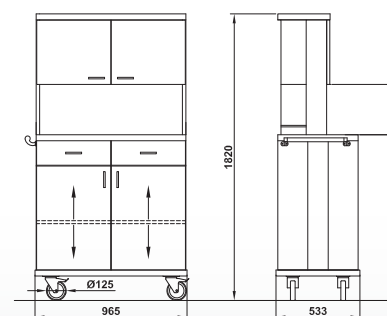

ALKOR	OPTIONALS
ALKOR 2 AP	PP/F - TR - K
ALKOR 2 AP B/R	PP/F - TR - K
ALKOR 2 CH	PP/F - TR - K
ALKOR 2 CH B/R	PP/F - TR - K



LBI	LFA	LNO	LWE	LCR	LTA
LPI	LAN	LSA	LNE	LRO	LNV

CONFIGURA IL TUO MOBILE
BUILD YOUR STATION ON
www.rocam.it



Moderni mobili di servizio su ruote in legno laminato con dettagli color alluminio. Modelli a 2 sportelli chiusi con ripiano interno, ripiano intermedio e alzata regolabile in altezza o parte superiore chiusa da sportelli. Al posto dei cassetti è possibile prevedere un portaposate aperto a 6 compartimenti (opt. PP/F). I mobili possono essere dotati di base rinforzata con ruote più grandi (Ø125mm) e maniglia di spinta (B/R). Opzionale tramoggia estraibile su guide scorrevoli con sacco in cotone asportabile e lavabile (opt. TR).



Modern dumbwaiters on castors made of laminated wood for the restaurant hall with aluminium-look details. Models with 2 doors with inner shelf, upper middle shelf can be height adjusted. The upper part can be closed by doors. Instead of drawers, dumbwaiters can be equipped with an open 6 compartments cutlery holder (opt. PP/F). They can be provided with a reinforced base with bigger castors (Ø125mm) and handle (B/R) and extractable hopper mounted on rails (opt. TR).



Modernes vaisseliers sur roues en bois melaminé avec détails couleur aluminium. Modèles avec 2 portes avec un étagère interne, l'étagère intermédiaire de la partie supérieure est réglable en hauteur. La partie supérieure peut être fermée par portes. Au lieu des tiroirs on peut monter un range-couvert à 6 compartiments (opt. PP/F). Les meubles peuvent avoir une base renforcée avec roues plus grandes (Ø125mm.) et poignée de poussée (B/R) et l'accessoire trémie escamotable sur guides coulissantes et avec sac en coton enlevable et lavable (opt. TR).



Modernes Service Board auf Rollen. Hergestellt aus Schichtholz für die Restoranthalle mit Alu-Look-Details. Modelle mit 2 Türen mit inneren Regalen. Das oberste Regal kann der mittleren Regal Höhe angepasst werden. Die obere Teil kann auch durch türen geschlossen werden. Statt mit Schubladen können die Speiseaufzüge mit einem offenem 6-fach-Besteckhalter (Opt. PP/F) ausgerüstet werden. Sie können mit einer verstärkten Basis mit größeren Rollen (Ø125mm) und Griff (B/R) und ausziehbarem Behälter montiert auf Schienen (Opt. TR) bereitgestellt werden.



Modernos muebles de servicio sobre ruedas, en madera laminada con detalles color aluminio. Modelos con 2 puertas y estante interior, el estante intermedio en la parte arriba se puede ajustar en altura. La parte arriba puede ser cerrada por puertas. En lugar de los cajones el mueble puede llevar un portacubiertos abierto con 6 compartimentos (opt. PP/F). Sobre pedido los muebles se proporcionan con base reforzada, ruedas más grandes (Ø125 mm.) y manija de empuje (B/R). Opcional tolva extraíble sobre guías deslizantes y saco en algodón removible y lavable (opt. TR).



ALKOR 3 AP

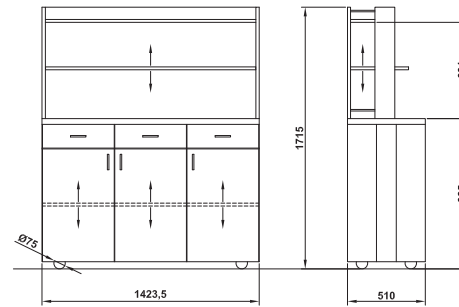

ALKOR 3 AP B/R

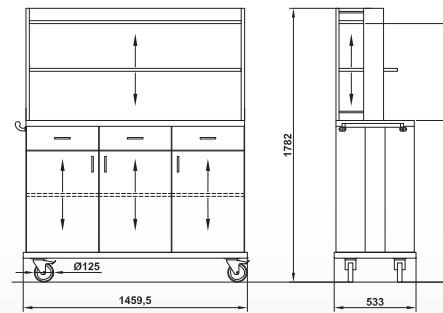

ALKOR 3 AP

OPTIONALS

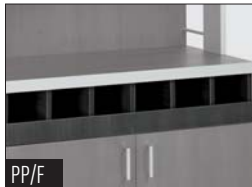

PP/F

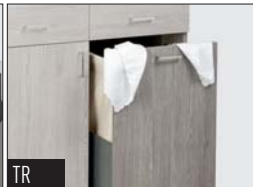

TR

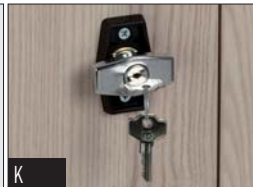

K

TUTTI I MOBILI SONO SU RUOTE.
ALL DUMBWAITERS ARE ON CASTORS.

ALKOR 3 CH + K



ALKOR 3 CH

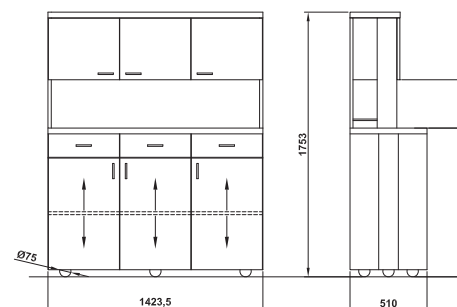

ALKOR 3 CH B/R

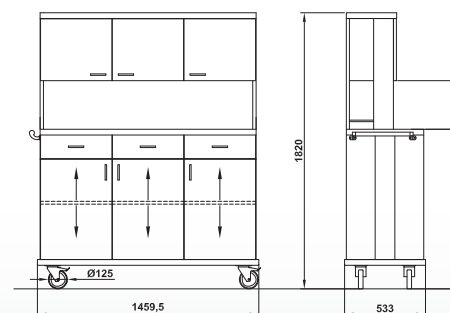

ALKOR	OPTIONALS
ALKOR 3 AP	PP/F - TR - K
ALKOR 3 AP B/R	PP/F - TR - K
ALKOR 3 CH	PP/F - TR - K
ALKOR 3 CH B/R	PP/F - TR - K



LBI	LFA	LNO	LWE	LCR	LTA
LPI	LAN	LSA	LNE	LRO	LNV

CONFIGURA IL TUO MOBILE
BUILD YOUR STATION ON
www.rocam.it

ALKOR 3 CH



Moderni mobili di servizio su ruote in legno laminato con dettagli color alluminio. Modelli a 3 sportelli chiusi con ripiano interno, ripiano intermedio e alzata regolabile in altezza o parte superiore chiusa da sportelli. Al posto dei cassetti è possibile prevedere un portaposate aperto a 9 scompartimenti (opt. PP/F). I mobili possono essere dotati di base rinforzata con ruote più grandi (Ø125mm) e maniglia di spinta (B/R). Opzionale tramoggia estraibile su guide scorrevoli con sacco in cotone asportabile e lavabile (opt. TR).



Modern dumbwaiters on castors made of laminated wood for the restaurant hall with aluminium-look details. Models with 3 doors with inner shelf, upper middle shelf can be height adjusted. The upper part can be closed by doors. Instead of drawers, dumbwaiters can be equipped with an open 9 compartments cutlery holder (opt. PP/F). They can be provided with a reinforced base with bigger castors (Ø125mm) and handle (B/R) and extractable hopper mounted on rails (opt. TR).



Modernes vaisseliers sur roues en bois melaminé avec détails couleur aluminium. Modèles avec 3 portes avec un étagère interne, l'étagère intermédiaire de la partie supérieure est réglable en hauteur. La partie supérieure peut être fermée par portes. Au lieu des tiroirs on peut monter un range-couvert à 9 compartiments (opt. PP/F). Les meubles peuvent avoir une base renforcée avec roues plus grandes (Ø125mm.) et poignée de poussée (B/R) et l'accessoire trémie escamotable sur guides coulissantes et avec sac en coton enlevable et lavable (opt. TR).



Modernes Service Board auf Rollen. Hergestellt aus Schichtholz für die Restoranthalle mit Alu-Look-Details. Modelle mit 3 Türen mit inneren Regalen. Das oberste Regal kann der mittleren Regal Höhe angepasst werden. Die obere teil kann auch durch türen geschlossen werden. Statt mit Schubladen können die Speiseaufzüge mit einem offenem 9-fach-Besteckhalter (Opt. PP/F) ausgerüstet werden. Sie können mit einer verstärkten Basis mit größeren Rollen (Ø125mm) und Griff (B/R) und ausziehbarem Behälter montiert auf Schienen (Opt. TR) bereitgestellt werden.



Modernos muebles de servicio sobre ruedas, en madera laminada con detalles color aluminio. Modelos con 3 puertas y estante interior, el estante intermedio en la parte arriba se puede ajustar en altura. La parte arriba puede ser cerrada por puertas. En lugar de los cajones el mueble puede llevar un portacubiertos abierto con 9 compartimentos (opt. PP/F). Sobre pedido los muebles se proporcionan con base refuerzada, ruedas más grandes (Ø125 mm.) y manija de empuje (B/R). Opcional tolva extraíble sobre guías deslizantes y saco en algodón removible y lavable (opt. TR).



ALKOR 2 B



ALKOR 3 B

ALKOR 2 B

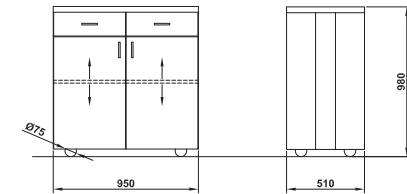

ALKOR 3 B

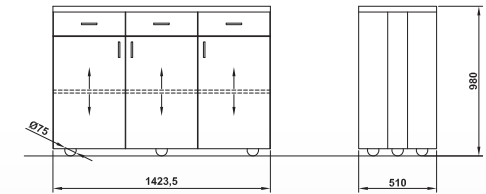

OPTIONALS



PP/F

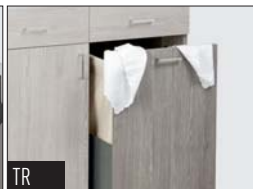

TR

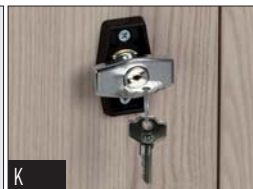

K

TUTTI I MOBILI SONO SU RUOTE.
ALL DUMBWAITERS ARE ON CASTORS.



ALKOR 2 B B/R

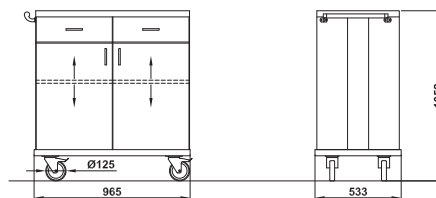

ALKOR 3 B B/R

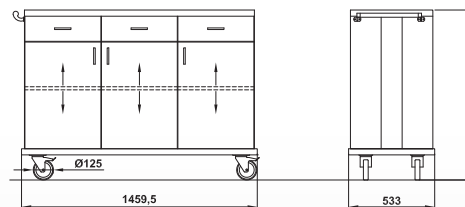

ALKOR	OPTIONALS
ALKOR 2 B	PP/F - TR - K
ALKOR 2 B B/R	PP/F - TR - K
ALKOR 3 B	PP/F - TR - K
ALKOR 3 B B/R	PP/F - TR - K



LBI	LFA	LNO	LWE	LCR	LTA
LPI	LAN	LSA	LNE	LRO	LNV

CONFIGURA IL TUO MOBILE
BUILD YOUR STATION ON
www.rocam.it

ALKOR 3 B B/R



Moderni mobili di servizio su ruote in legno laminato con dettagli color alluminio. Modelli a 2 o 3 sportelli chiusi con ripiano interno, ripiano intermedio e alzata regolabile in altezza. Al posto dei cassetti è possibile prevedere un portaposate aperto a 6-9 scompartimenti (opt. PP/F). I mobili possono essere dotati di base rinforzata con ruote più grandi (Ø125mm) e maniglia di spinta (B/R). Opzionale tramoggia estraibile su guide scorrevoli con sacco in cotone asportabile e lavabile (opt. TR).



Modern dumbwaiters on castors made of laminated wood for the restaurant hall with aluminium-look details. Models with 2 or 3 doors with inner shelf, upper middle shelf can be height adjusted. Instead of drawers, dumbwaiters can be equipped with an open 6-9 compartments cutlery holder (opt. PP/F). They can be provided with a reinforced base with bigger castors (Ø125mm) and handle (B/R) and extractable hopper mounted on rails (opt. TR).



Modernes vaisseliers sur roues en bois melaminé avec détails couleur aluminium. Modèles avec 2 ou 3 portes avec un étagère interne, l'étagère intermédiaire de la partie supérieure est réglable en hauteur. Au lieu des tiroirs on peut monter un range-couverts à 6-9 compartiments (opt. PP/F). Les meubles peuvent avoir une base renforcée avec roues plus grandes (Ø125mm.) et poignée de poussée (B/R) et l'accessoire trémie escamotable sur guides coulissantes et avec sac en coton enlevable et lavable (opt. TR).



Modernes Service Board auf Rollen. Hergestellt aus Schichtholz für die Restoranthe mit Alu-Look-Details. Modelle mit 2 oder 3 Türen mit inneren Regalen. Das oberste Regal kann der mittleren Regal Höhe angepasst werden. Statt mit Schubladen können die Speiseaufzüge mit einem offenem 6-9-fach-Besteckhalter (Opt. PP/F) ausgerüstet werden. Sie können mit einer verstärkten Basis mit größeren Rollen (Ø125mm) und Griff (B/R) und ausziehbarem Behälter montiert auf Schienen (Opt. TR) bereitgestellt werden.



Modernos muebles de servicio sobre ruedas, en madera laminada con detalles color aluminio. Modelos con 2 o 3 puertas y estante interior, el estante intermedio en la parte arriba se puede ajustar en altura. En lugar de los cajones el mueble puede llevar un portacubiertos abierto con 6-9 compartimientos (opt. PP/F). Sobre pedido los muebles se proporcionan con base reforzada, ruedas más grandes (Ø125 mm.) y manija de empuje (B/R). Opcional tolva extraíble sobre guías deslizantes y saco en algodón removible y lavable (opt. TR).



POLAR 2 AP INOX



POLAR 2 AP INOX + PP/F

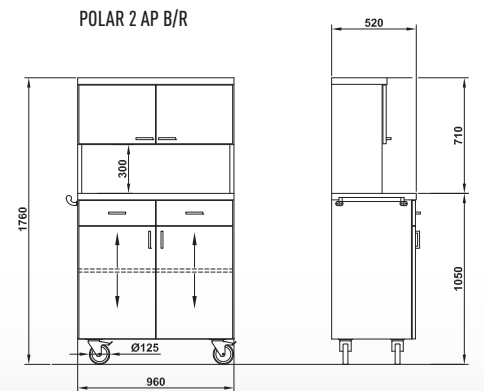
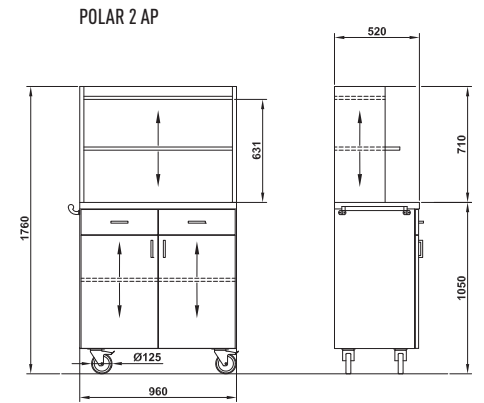

OPTIONALS



PP/F



PP/F



POLAR	OPTIONALS
POLAR 2 AP IN	PP/F
POLAR 2 CH IN	PP/F

CONFIGURA IL TUO MOBILE
BUILD YOUR STATION ON
www.rocamlt

POLAR 2 CH INOX

POLAR 2 CH INOX + PP/F



Per ottimizzare il servizio all'esterno è disponibile una linea di mobili costruita interamente in acciaio inox AISI 304. La versione alta di questo mobile può avere la parte superiore aperta con 2 ripiani oppure completamente chiusa da 2 pratiche antine. Tutti i modelli sono dotati di ruote Ø125mm di cui 2 con freno e una comoda maniglia di spinta. Per una gestione ottimale delle posate è possibile scegliere la versione con 2 cassetti oppure con il pratico portaposate a 6 scomparti (Opt. PP/F) chiuso da uno sportello.



To optimize the outdoor service it's available a line of dumbwaiters built completely in stainless steel AISI 304. The high models can have an open upper part with 2 shelves or completely closed by 2 small doors. Each dumbwaiter is mounted on wheels Ø125mm., 2 with brakes and a practical pushing handle. To organize cutlery are available dumbwaiters with 2 drawers or with 6 compartments closed by a small door (Opt. PP/F).



Pour optimiser le service au dehors est disponible une ligne de vaisseliers construite complètement en acier inox AISI 304. Les modèles hauts peuvent avoir la partie supérieure avec 2 étagères ou complètement fermée par 2 portillons. Tous vaisseliers sont montés sur roues Ø125mm, dont 2 à frein et avec une pratique poignée de pousse. Pour organiser les couverts sont disponibles les vaisseliers avec 2 tiroirs ou avec un porte-couverts à 6 casiers fermé par une porte (Opt. PP/F).



Um den Außenservice zu optimieren, schlagen wir eine Linie komplett aus Edelstahl AISI 304 vor. Die hohe Version dieses Boards kann die Oberseite mit 2 Etagen geöffnet haben oder durch zwei Türen geschlossen haben. Alle Modelle sind mit Rädern Ø125mm davon 2 mit Bremse und eine praktische Schiebegriff ausgestattet. Für eine optimale Verwaltung von Besteck können Sie die Version mit 2 Schubladen oder mit 6 Fach für Besteck (Opt. PP / F) wählen.



Para optimizar el servicio al exterior hay una línea de muebles hecha completamente de acero inoxidable AISI 304. La versión alta de este mueble puede tener la parte superior abierta con 2 estantes o completamente cerrada por dos prácticas puertas. Todos los modelos están equipados con ruedas Ø125mm, 2 con freno y una manija de empuje. Para una gestión de los cubiertos se puede elegir la versión con 2 cajones o con el práctico portacubiertos con 6 compartimentos (Opt. PP / F) cerrado por una puerta.



POLAR 2 B INOX



POLAR 2 B INOX + PPF

OPTIONALS



PP/F



POLAR 2 B



POLAR 2 B + PP/F

POLAR 2 B INOX

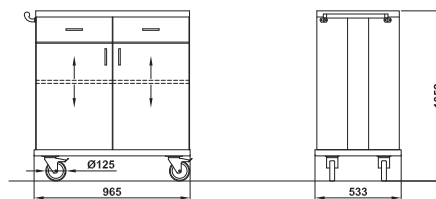

POLAR	OPTIONALS
POLAR 2 B	PP/F

CONFIGURA IL TUO MOBILE
BUILD YOUR STATION ON
www.rocam.it



La linea Polar è disponibile anche in versione bassa. Tutti i modelli sono dotati di ruote Ø125mm di cui 2 con freno e una comoda maniglia di spinta. Per una gestione ottimale delle posate è possibile scegliere la versione con 2 cassetti oppure con il pratico portaposate a 6 scomparti (Opt. PP/F) chiuso da uno sportello.



Polar line is also available in a low version. Each dumbwaiter is mounted on wheels Ø125mm., 2 with brakes and a practical pushing handle. To organize cutlery are available dumbwaiters with 2 drawers or with 6 compartments closed by a small door (Opt. PP/F).



Pour optimiser le service au dehors est disponible une ligne de vaisseliers construite complètement en acier inox AISI 304. Les modèles hauts peuvent avoir la partie supérieure avec 2 étages ou complètement fermée par 2 portillons. Tous vaisseliers sont montés sur roues Ø125mm, dont 2 à frein et avec une pratique poignée de pousse. Pour organiser les couverts sont disponibles les vaisseliers avec 2 tiroirs ou avec un porte-couverts à 6 casiers fermé par une porte (Opt. PP/F).



Polar Linie ist auch in einer niedrigen Version verfügbar. Alle Modelle sind mit Rädern Ø125mm davon 2 mit Bremse und eine praktische Schiebegriff ausgestattet. Für eine optimale Verwaltung von Besteck können Sie die Version mit 2 Schubladen oder mit 6 Fach für Besteck (Opt. PP/F) wählen.



Línea de Polar está disponible también en la versión baja. Todos los modelos están equipados con ruedas Ø125mm, 2 con freno y una manija de empuje. Para una gestión de los cubiertos se puede elegir la versión con 2 cajones o con el práctico porta-cubiertos con 6 compartimentos (Opt. PP/F) cerrado por una puerta.



PERSEO A/2 +PP/F+B/R+PER/CO



PERSEO A/2 +PP/F+B/R+PER/CO



PERSEO A/2 + PP/F

OPTIONALS



PER/CO



B/R

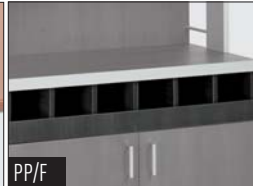

PP/F

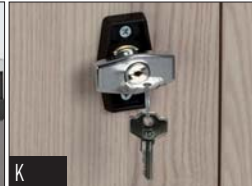

K

TUTTI I MOBILI SONO SU RUOTE.
ALL DUMBWAITERS ARE ON CASTORS.





PERSEO A1

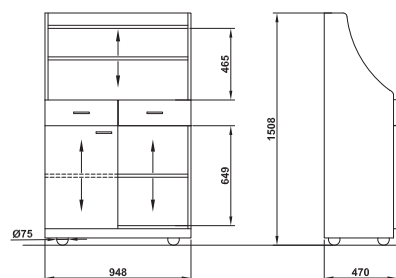

PERSEO A2

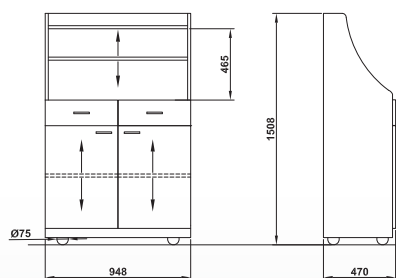

PERSEO	OPTIONALS
PERSEO A1	B/R - PP/F - PER/CO - K
PERSEO A2	B/R - PP/F - PER/CO - K



LBI	LFA	LNO	LWE	LCR	LTA
LPI	LAN	LSA	LNE	LRO	LNV

CONFIGURA IL TUO MOBILE
BUILD YOUR STATION ON
www.rocam.it

PERSEO A/1



Mobili di servizio su ruote in legno laminato per la sala ristorante. Modelli con 2 cassetti e 1 o 2 sportelli con ripiano interno. Al posto dei cassetti è possibile avere un portaposate aperto a 6 scompartimenti (opt. PP/F). I mobili possono essere dotati di base rinforzata con ruote più grandi (Ø125mm) e maniglia di spinta (opt. B/R), è inoltre disponibile una copertura di protezione in poliestere (opt. PER/CO).



Dumbwaiters on castors made of laminated wood for the restaurant hall. Models with 2 drawers and 1 or 2 doors with inner shelf. Instead of drawers, dumbwaiters can be equipped with an open 6-compartment cutlery holder (opt. PP/F). They can be provided with a reinforced base with bigger castors (Ø125mm) and handle (opt. B/R) and a polyester protection covering (opt. PER/CO).



Vaisselle sur roues en bois melaminé pour la salle restaurant. Modèles avec 2 tiroirs et 1 ou 2 portes avec étagère interne. Au lieu des tiroirs on peut monter un range-couverts à 6 compartiments (opt. PP/F). Les meubles peuvent avoir une base renforcée avec roues plus grandes (Ø125mm.) et poignée de poussée (opt. B/R). De plus est disponible une housse de protection en polyester (opt. PER/CO).



Service-Board auf Rollen aus melaminharzbeschichtetem Holz. Mit 2 Schubladen und 1 oder 2 Türen mit Einlegeböden. Statt Schubladen können die Boards auch mit einem offenen 6-fach Besteckhalter (opt. PP/F) ausgestattet werden. Auch mit verstärktem Boden, mit größeren Rollen (Ø125mm) und Griff (opt. B/R) und einer Schützhülle aus Polyester (opt. PER/CO) lieferbar.



Muebles de servicio sobre ruedas, en madera laminada para la sala restaurante. Modelos con 2 cajones y 1 o 2 puertas con estante interior. En lugar de los cajones el mueble puede llevar un portacubiertos abierto con 6 compartimentos (opt. PP/F). Sobre pedido los muebles se proporcionan con base reforzada, ruedas más grandes (Ø125mm) y manija de empuje (OPT. B/R). Además, es posible añadir una cobertura de polyester (opt. PER/CO).



PERSEO A/T



PERSEO A/TA

PERSEO A/T

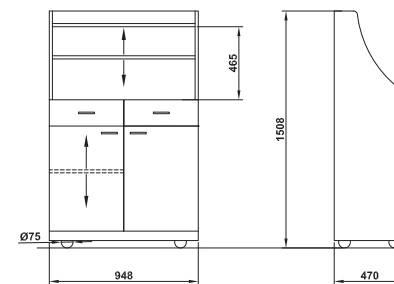

PERSEO A/TA

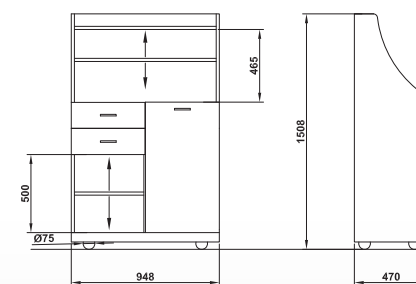

OPTIONALS

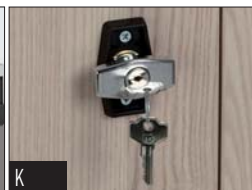

TUTTI I MOBILI SONO SU RUOTE.
ALL DUMBWAITERS ARE ON CASTORS.





PERSEO H/1

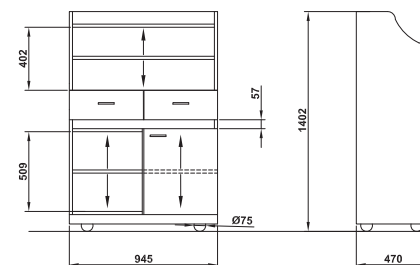

PERSEO H/2

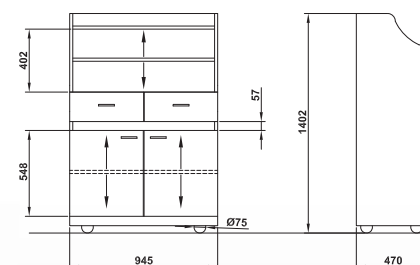

PERSEO	OPTIONALS
PERSEO A/T	B/R - PP/F - PER/CO - K
PERSEO A/TA	B/R - PER/CO - K
PERSEO H/1	B/R - PP/F - PER/CO - K
PERSEO H/2	B/R - PP/F - PER/CO - K



LBI	LFA	LNO	LWE	LCR	LTA
LPI	LAN	LSA	LNE	LRO	LVN

CONFIGURA IL TUO MOBILE
BUILD YOUR STATION ON
www.rocam.it

PERSEO H/1

PERSEO H/2



Mobili di servizio su ruote in legno laminato per la sala ristorante. Modelli con 2 cassetti e 1 o 2 sportelli con ripiano interno. Al posto dei cassetti è possibile avere un portaposate aperto a 6 scompartimenti (opt. PP/F). La versione H prevede uno spazio portamenù. I mobili possono essere dotati di base rinforzata con ruote più grandi (Ø125mm) e maniglia di spinta (opt. B/R), è inoltre disponibile una copertura di protezione in poliestere (opt. PER/CO).



Dumbwaiters on castors made of laminated wood for the restaurant hall. Models with 2 drawers and 1 or 2 doors with inner shelf. Instead of drawers, dumbwaiters can be equipped with an open 6-compartment cutlery holder (opt. PP/F). The H version is equipped by a useful menus-holder. They can be provided with a reinforced base with bigger castors (Ø125mm) and handle (opt. B/R) and a polyester protection covering (opt. PER/CO).



Vaisselle sur roues en bois melaminé pour la salle restaurant. Modèles avec 2 tiroirs et 1 ou 2 portes avec étagère interne. Au lieu des tiroirs on peut monter un range-couverts à 6 compartiments (opt. PP/F). La version H prévoit un espace porte-menus. Les meubles peuvent avoir une base renforcée avec roues plus grandes (Ø125mm.) et poignée de poussée (opt. B/R). De plus est disponible une housse de protection en polyester (opt. PER/CO).



Service-Board auf Rollen aus melaminharzbeschichtetem Holz. Mit 2 Schubladen und 1 oder 2 Türen mit Einlegeböden. Statt Schubladen können die Boards auch mit einem offenen 6-fach Besteckhalter (opt. PP/F) ausgestattet werden. Die H-Version ist mit einem nützlichen Raum fuer die Menus ausgestattet. Auch mit verstärktem Boden, mit größeren Rollen (Ø125mm) und Griff (opt. B/R) und einer Schützhülle aus Polyester (opt. PER/CO) lieferbar.



Muebles de servicio sobre ruedas, en madera laminada para la sala restaurante. Modelos con 2 cajones y 1 o 2 puertas con estante interior. En lugar de los cajones el mueble puede llevar un portacubiertos abierto con 6 compartimentos (opt. PP/F). La version H ofrece un cómodo espacio para los menús. Sobre pedido los muebles se proporcionan con base reforzada, ruedas más grandes (Ø125mm) y manija de empuje (OPT. B/R). Además, es posible añadir una cobertura de polyester (opt. PER/CO).



PERSEO G

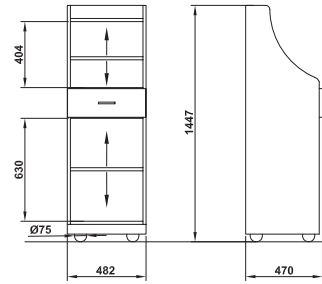

PERSEO 75

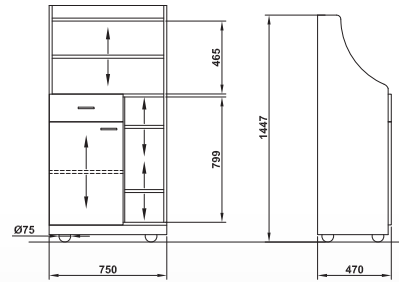

PERSEO G

PERSEO 75

PERSEO B/2

OPTIONALS



B/R



PP/F

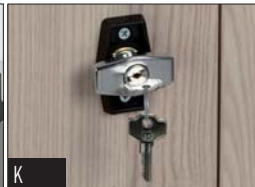

K

TUTTI I MOBILI SONO SU RUOTE.
ALL DUMBWAITERS ARE ON CASTORS.



PERSEO B/2

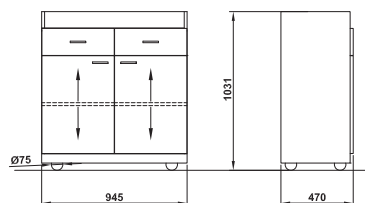

PERSEO B/TA

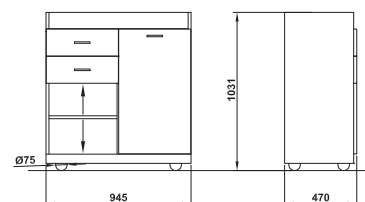

PERSEO	OPTIONALS
PERSEO G	K
PERSEO 75	B/R - PP/F - K
PERSEO B/2	B/R - PP/F - K
PERSEO B/TA	B/R - K



LBI	LFA	LNO	LWE	LCR	LTA
LPI	LAN	LSA	LNE	LRO	LNV

CONFIGURA IL TUO MOBILE
BUILD YOUR STATION ON
www.rocam.it

PERSEO B/TA



Mobili di servizio su ruote in legno laminato per la sala ristorante. Svariati modelli con cassetti, sportelli o tramogge estraibili su guide scorrevoli. A seconda del modello i mobili possono avere un portaposate aperto a 3-6 scompartimenti (opt. PP/F), tranne i modelli a 1 cassetto, tutti i mobili possono essere dotati di base rinforzata con ruote più grandi (Ø125mm) e maniglia di spinta (opt. B/R).



Dumbwaiters on castors made of laminated wood for the restaurant hall. Several models with drawers, doors or extractable hoppers mounted on rails. Instead of drawers, dumbwaiters can be equipped with an open 3-6-compartment cutlery holder (opt. PP/F), except the models with 1 drawer, each dumbwaiter can be provided with a reinforced base with bigger castors (Ø125mm) and a handle (opt. B/R).



Vaisselle sur roues en bois melaminé pour la salle restaurant. Nombreux modèles avec tiroirs, portes ou trémies escamotables sur guides coulissantes. Au lieu des tiroirs on peut monter un porte-couverts à 3-6 compartiments (opt. PP/F), sauf les modèles avec 1 tiroir. Les meubles peuvent avoir une base renforcée avec roues plus grandes (Ø125mm.) et poignée de poussée (opt. B/R).



Service Board aus melaminharzbeschichtetem Holz auf Rollen. Mehrere Modelle mit Schubladen, Türen oder Ausziehfach. Statt Schubladen können die Boards mit einem offenen 3-6-fach Besteckhalter (opt. PP/F) (außer die Modelle mit 1 Schublade ausgestattet werden). Auch mit verstärktem Boden, mit größeren Rollen (Ø125mm) und Griff (opt. B/R) und einer Schützhülle aus Polyester (opt. PER/CO) lieferbar.



Muebles de servicio sobre ruedas, en madera laminada para la sala restaurante. Varios modelos con cajones, puertas y tolvas extraíbles sobre guías deslizantes. Según los modelos pueden llevar un portacubiertos abierto con 3-6 compartimentos (opt. PP/F), excepto los modelos con 1 cajón. Sobre pedido los muebles se proporcionan con base reforzada, ruedas más grandes (Ø125mm) y manija de empuje (OPT. B/R).



MEDUSA 3/AL



MEDUSA 3/2



MEDUSA 2/AL

OPTIONALS



B/R



PP/F

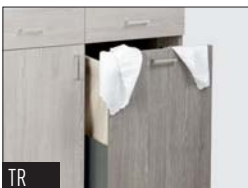

TR

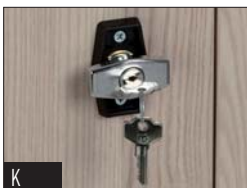

K





MEDUSA 3/AL

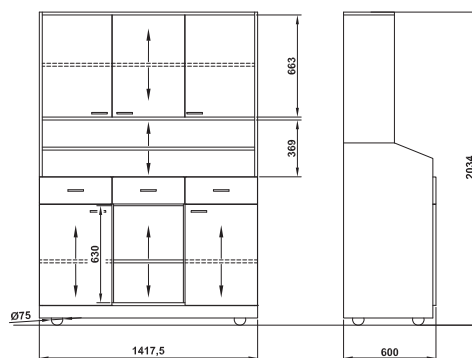

MEDUSA 2/AL

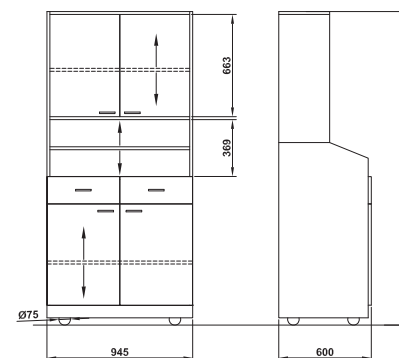

MEDUSA 3/2

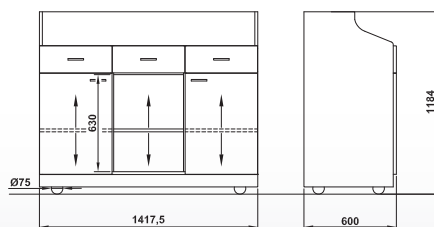

MEDUSA 2/2

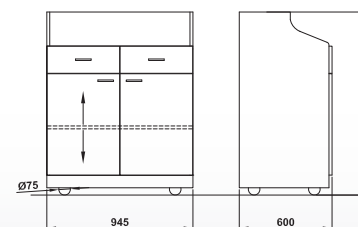

MEDUSA	OPTIONALS
MEDUSA 2/2	TR - B/R - PP/F - K
MEDUSA 2/AL	TR - B/R - PP/F - K
MEDUSA 3/2	TR - B/R - PP/F - K
MEDUSA 3/AL	TR - B/R - PP/F - K



LBI	LFA	LNO	LWE	LCR	LTA
LPI	LAN	LSA	LNE	LRO	LVN

CONFIGURA IL TUO CARRELLO
BUILD YOUR TROLLEY ON
www.rocaml.it

MEDUSA 2/2



Mobili di servizio su ruote in legno laminato per la sala ristorante a due o tre sportelli con una profondità di 60cm. Possono essere dotati di base rinforzata con ruote più grandi (Ø125mm) e maniglia di spinta (opt. B/R). I modelli con alzata possono essere dotati di sportelli con vetro sabbato (opt. S/VE).



Dumbwaiters on castors made of laminated wood for the restaurant hall with 2 or 3 drawers. 60cm. width. They can be provided with a reinforced base with bigger castors (Ø125mm) and handle (opt. B/R). Models 2/AL and 3/AL can be equipped with doors with frosted glass (opt. S/VE).



Vaisselle sur roues en bois melaminé pour la salle restaurant avec 2 ou 3 portes avec une profondeur de 60 cm. Les meubles peuvent avoir une base renforcée avec roues plus grandes (Ø125mm.) et poignée de poussée (opt. B/R). Les modèles 2/AL et 3/AL peuvent être dotés de portes avec verre sablé (opt. S/VE).



Service-Board aus melaminharzbeschichtetem Holz mit 2 oder 3 Schubladen. Sie können mit einem verstärktem Boden, mit größeren Rollen (Ø125mm) und Griff (opt. B/R) geliefert werden. Model 2/AL und 3/AL kann mit Milchglästüren (opt. S/VE) ausgestattet werden.



Muebles de servicio sobre ruedas, en madera laminada para la sala restaurante con 2 o 3 puertas y profundidad 60 cm. Pueden llevar base reforzada, ruedas más grandes (Ø125mm) y manija de empuje (OPT. B/R). Los modelos con parte superior se pueden suministrar con puertas con vidrio esmerilado.



KITCHEN EQUIPMENTS

La ricerca di nuove soluzioni e l'innovazione sui prodotti già esistenti sono le basi per garantire una gamma di articoli che può rispondere a tutte le esigenze degli operatori professionali. Le nostre attrezzature si differenziano non solo per l'alto valore tecnologico che semplifica il lavoro degli operatori professionali, ma anche per la loro essenzialità nelle forme.



Looking for new solutions and innovation on existing articles are the starting points to guarantee a product range that can answer to each requirement of professionals. Our equipments are characterized not only by the high technology which makes work simpler, but also for the essential forms of items.

La recherche de nouvelles solutions et l'innovation sur les produits existants sont à la base pour assurer une gamme de articles qui peuvent répondre à tous les besoins des professionnels. Notre équipements se différencient soit pour la haute valeur technologique qui simplifie le travail des professionnels, mais aussi pour leur essentialité dans les formes.

Die Suche nach neuen Lösungen und Innovationen auf die bestehenden Artikel sind die Grundlage um, eine Produktgamme die alle Bedürfnisse der Profis zu erfüllen kann. Unsere Geräte unterscheiden sich nicht nur für den hohen technologischen Wert, der die Arbeit der professionellen Betreibern erleichtert, sondern auch für ihre Wesentlichkeit in den Formen.

La búsqueda de nuevas soluciones y la innovación en los productos existentes son la base para asegurar una gama de productos que pueden satisfacer todas las necesidades de los profesionales. Nuestros equipos se diferencian no sólo por el alto valor tecnológico, que simplifica el trabajo de los operadores profesionales, sino también por su esencialidad en las formas.



PLEIADI T



PLEIADI C (+ 6x PLEIADI T)



2 griglie incluse.
2 grid included.

PLEIADI T

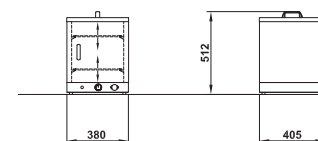

PLEIADI C

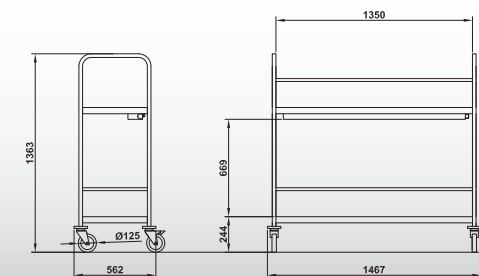

Box termico per il servizio in camera. Costruzione in acciaio inox AISI 304 a doppia parete coibentata. Termostato analogico 30-90°C con spia luminosa di funzionamento. Fornito con due griglie interne regolabili in altezza. Idoneo per piatti fino a Ø32cm. Utilizzando il carrello PLEIADI C possono essere stoccati e preriscaldati fino a 6 box termici PLEIADI T. Dotato di 2 ruote con freno di serie.



Hot box for room service. Entirely made of AISI 304 stainless steel with double insulated wall. 30-90°C analogic thermostat with indicator light. Supplied with 2 inner height-adjustable grids. Suitable for dishes up to Ø32cm. PLEIADI C trolley suitable for stocking and pre-heating of 6 PLEIADI T hot boxes. 2 Castors with brake included.



Caisson thermique pour le room service. Construction en acier inox AISI 304 à double paroi isolée. Thermostat mécanique 30°-90°C avec voyant lumineux. Fourni avec deux grilles interne réglable. Pour assiettes jusqu'à Ø32cm. Pour chauffer et transporter jusqu'à 6 box thermiques PLEIADI T est disponible le chariot PLEIADI C. Doté de 2 roues à frein incluses.



Elektrische Wärmebox für den Zimmerservice. Passend zu den Zimmerservice-Tischen. Komplett aus Edelstahl AISI 304 mit doppelt isolierten Wänden. Die Temperatur (30-90°C) wird mit einem analogen Thermostat mit Kontrollleuchte geregelt. Geeignet für Teller bis Ø 32 cm. Inklusive 2 höhenverstellbarem Gitter. PLEIADI C: Rollwagen für 6 PLEIADI T Wärmeboxen inkl. Stromanschluß an jedem Stellplatz. Für Transport und Vorwärmung der Wärmeboxen. Inklusive 4 Lenkrollen, davon 2 Bremsrollen.



Cajón térmico para el servicio de habitaciones. Fabricado en acero inoxidable AISI 304 con doble pared aislada. Termostato analógico 30-90°C con indicador de funcionamiento. Equipado con doble rejilla interior ajustable en altura. Para platos hasta Ø32cm. El modelo PLEIADI C puede almacenar y precalentar hasta 6 cajones térmicos PLEIADI T. Dotado de 2 ruedas con freno.



PLEIADI F + PLEIADI T



PLYWOOD TOP

PLEIADI F

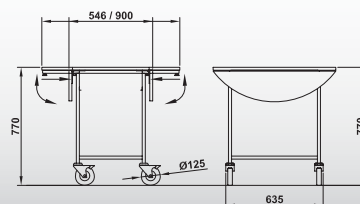

PLEIADI	⚡ 230V max
PLEIADI T	500 W
PLEIADI C	-
PLEIADI F	-

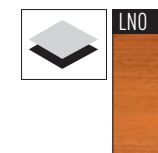

CONFIGURA IL TUO CARRELLO
BUILD YOUR TROLLEY ON
www.rocamin.it



Tavolino per il servizio in camera. Piano Ø90cm. molto resistente in legno multistrato con flaps pieghevoli per attraversare porte e ascensori. Struttura in tubo cromato, 2 ruote con freno di serie. Può trasportare fino a 2 box termici PLEIADI T.



Room service table. Very sturdy top Ø90cm. made of plywood with fold down flaps for an easy crossing of doors and lifts. Chromed tube structure, 2 castors with brake included. Suitable to carry up to 2 PLEIADI T hot boxes.



Table roulante pour le room service. Plateau Ø90 cm. très résistant en bois stratifié avec parties latérales rabattables pour passer à travers portes et ascenseurs. Structure en tube chromé, 2 roues à frein de série. Peut transporter jusqu'à 2 box thermiques PLEIADI T.



Zimmerservice-Tische aus melaminharzbeschichtetem Massivholz und verchromtem Stahl. Robuste Ausführung Ø90cm, mit klappbaren Seiten, die das Passieren durch Türen und Aufzüge erleichtern. Inklusive 4 Lenkrollen, davon 2 als Bremsrolle. Er ist geeignet um bis zu 2 PLEIADI T Wärmeboxen auf dem Untergestell zu transportieren.



Mesa para el servicio de habitaciones. Top Ø90cm muy resistente en madera multicapa con aletas plegables para pasar a través de puertas y ascensores. Estructura en tubular cromado, dos ruedas con freno incluidas. Puede transportar hasta 2 cajones térmicos PLEIADI T.

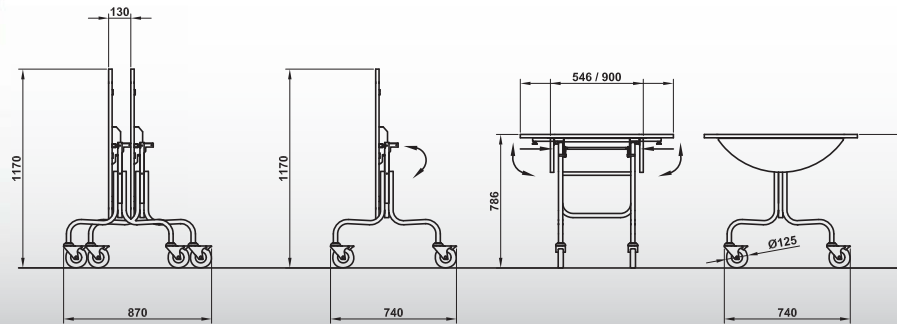

PLEIADI R + PLEIADI T



Tavolino per il servizio in camera ribaltabile e impilabile quando non in uso. Piano Ø90cm. molto resistente in legno multistrato con flaps pieghevoli per attraversare porte e ascensori. Struttura in tubo cromato, 2 ruote con freno di serie. Può trasportare fino a 2 box termici PLEIADI T.



Room service table with capsizable top for stacking when not in use. Very sturdy top Ø90cm. made of plywood with tip-up flaps for an easy crossing of doors and lifts. Chromed tube structure, 2 castors with brake included. Suitable to carry up to 2 PLEIADI T hot boxes.



Table roulante pour le room service et emboîtable grâce au plateau Ø90 cm basculant et très résistant en bois stratifié avec parties latérales rabattables pour passer à travers portes et ascenseurs. Structure en tube chromé, 2 roues à frein de série. Peut transporter jusqu'à 2 box thermiques PLEIADI T.



Zimmerservice-Tisch aus melaminharzbeschichtetem Massivholz und verchromtem Stahl. Tischplatte komplett kippbar und dann stapelbar. Dadurch ist eine platzsparende Aufbewahrung möglich. Robuste Ausführung Ø90cm, mit klappbaren Seiten, die das Passieren durch Türen und Aufzüge erleichtern. Inklusive 4 Lenkrollen, davon 2 als Bremsrolle. Er ist geeignet, um bis zu 2 PLEIADI T Wärmeboxen auf dem Untergestell zu transportieren.



Mesa para el servicio de habitaciones abatible y apilable cuando no está en servicio. Top Ø90cm muy resistente en madera multicapa con aletas plegables para pasar a través de puertas y ascensores. Estructura en tubular cromado, dos ruedas con freno incluidas. Puede transportar hasta 2 cajones térmicos PLEIADI T.

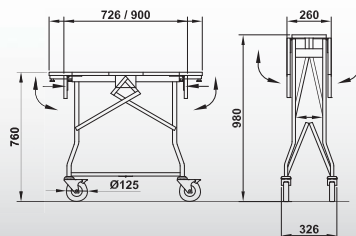

PLEIADI

- PLEIADI R
- PLEIADI P



LNO



CONFIGURA IL TUO CARRELLO
BUILD YOUR TROLLEY ON
www.rocamlit

PLEIADI P + PLEIADI T



Tavolino per il servizio in camera pieghevole per ridurre l'ingombro quando non in uso (solo 33 cm.). Piano Ø90cm. molto resistente in legno multistrato con flaps pieghevoli per attraversare porte e ascensori. Struttura in tubo cromato, 2 ruote con freno di serie.



Completely foldable room service table for saving space when not in use (only 33 cm.). Very sturdy top Ø90cm. made of plywood with tip-up flaps for an easy crossing of doors and lifts. Chromed tube structure, 2 castors with brake included.



Table roulante pour le room service totalement pliable pour réduire l'encombrement (seulement 33 cm. de largeur). Plateau Ø90 cm. très résistant en bois stratifié avec parties latérales rabattables pour passer à travers portes et ascenseurs. Structure en tube chromé, 2 roues à frein de série.



Zusammenklappbarer Zimmerservice-Tisch. Dadurch sehr platzsparende Aufbewahrung (33 cm) möglich. Aus melaminharzbeschichtetem Massivholz und verchromtem Stahl. Robuste Ausführung Ø90cm, mit klappbaren Seiten, die das Passieren durch Türen und Aufzüge erleichtern. Inklusive 4 Lenkrollen, davon 2 als Bremsrolle.



Mesa para el servicio de habitaciones abatible para ahorrar espacio cuando no está en uso (solo 33). Top Ø90cm muy resistente en madera multicapa con aletas plegables para pasar a través de puertas y ascensores. Estructura en tubular cromado, dos ruedas con freno incluidas.

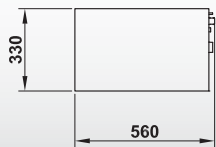
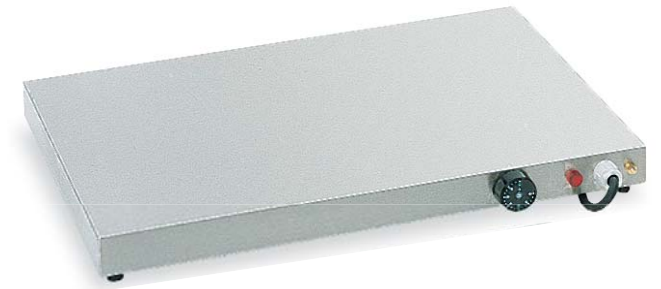

GN

1/1

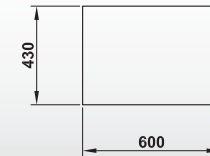
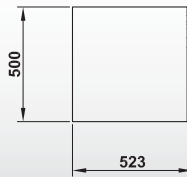

VULCANO G

VULCANO 50x50

VULCANO 60x40



VULCANO	⚡ 230V _{max}	GN
VULCANO 1/1	500 W	1 GN 1/1
VULCANO 2/1	750 W	2 GN 1/1
VULCANO 3/1	1500 W	3 GN 1/1
VULCANO 4/1	1500 W	4 GN 1/1
VULCANO 50x50	750 W	-
VULCANO 60x40	750 W	-
VULCANO G	750 W	1 GN 1/1

SCHEDE TECNICHE
TECHNICAL SHEET
www.rocaml.com

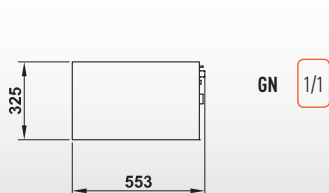

VULCANO 1/1

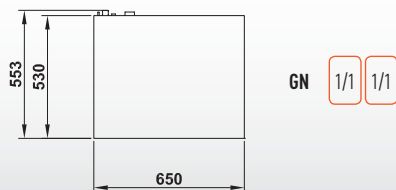

VULCANO 2/1

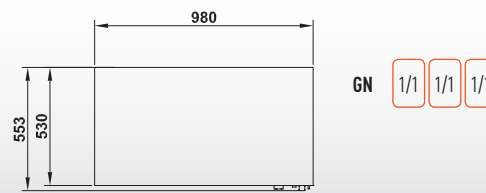

VULCANO 3/1

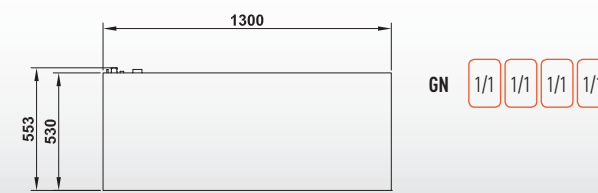

VULCANO 4/1



Piani caldi in diverse misure in acciaio inox AISI 304. Riscaldamento a secco con termostato meccanico (+30°/+90°C) e spia luminosa di funzionamento. VULCANO G: piano in vetro temperato nero, con termostato meccanico (+30°/+90°C) e con spia luminosa di funzionamento.



Warming plates available in different dimensions made of AISI 304 stainless steel structure. Dry-heating with mechanical thermostat (+30°/+90°C) with indicator light. VULCANO G: Black tempered glass shelf with mechanical thermostat (+30°/+90°C) with indicator light.



Plaques chauffantes en acier inox AISI 304 en nombreuses dimensions. Chauffage à sec avec thermostat mécanique (+30°/+90°C) et voyant lumineux de fonctionnement. VULCANO G: plaque chauffante en verre trempé noir avec thermostat mécanique (+30°/+90°C) et voyant lumineux de fonctionnement.



Wärmeplatten in verschiedenen Größen aus AISI 304 Edelstahl. Die Temperatur wird mit einem mechanischen Thermostat mit Kontrollleuchte geregelt (+30°/+90°C). VULCANO G: Schwarz gehärtetes Glas. Die Temperatur wird mit einem mechanischen Thermostat mit Kontrollleuchte geregelt (+30°/+90°C).



Gama de placas calientes de acero inoxidable en diferentes medidas. Calentamiento en seco con termostato mecánico (+30°/+90°C), con luz de encendido. VULCANO G: placa en vidrio templado negro, con termostato mecánico (+30°/+90°C) y con luz de encendido.

PIANI CALDI INFRA - CARVING STATIONS

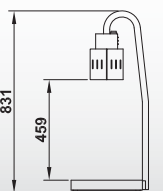
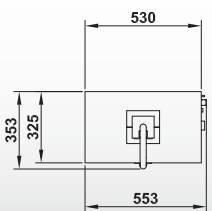
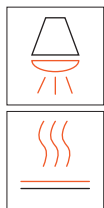

GN 1/1

VULCANO 1/1 INFRA

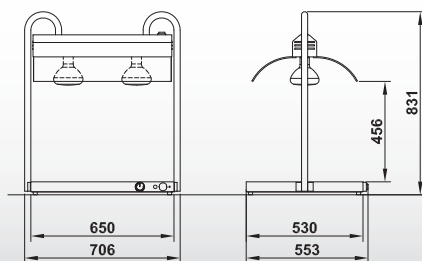

GN 1/1 1/1

VULCANO 2/1 INFRA

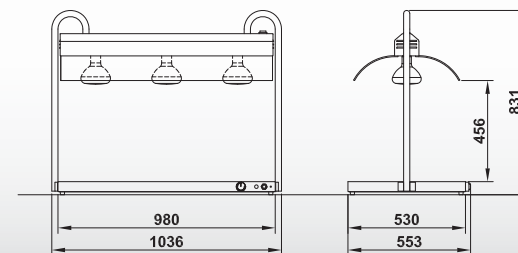

GN 1/1 1/1 1/1

VULCANO 3/1 INFRA



VULCANO	⚡ 230V max	GN
VULCANO 1/1 INFRA	500+250 W	1 GN 1/1
VULCANO 2/1 INFRA	750+500 W	2 GN 1/1
VULCANO 3/1 INFRA	1500+750 W	3 GN 1/1
VULCANO 4/1 INFRA	1500+1000 W	4 GN 1/1

SCHEDE TECNICHE
TECHNICAL SHEET
www.rocamin.it

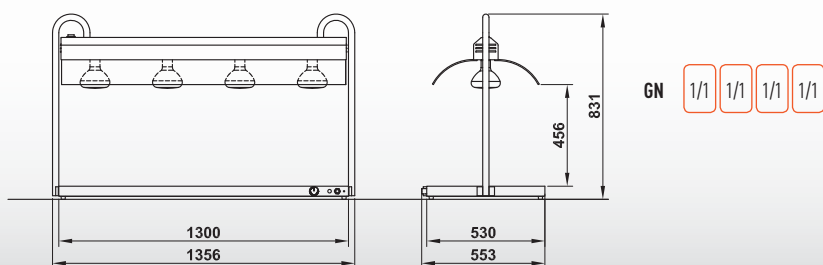

VULCANO 4/1 INFRA



Piani caldi in diverse misure in acciaio inox AISI 304 con alzata con lampade ad infrarossi. Riscaldamento a secco con termostato meccanico (+30°/+90°C) e spia luminosa di funzionamento. Lampade ad accensione indipendente con pulsante luminoso.



Warming plates in different dimensions made of AISI 304 stainless steel structure with infrared lamps stand. Dry-heating with mechanical thermostat (+30°/+90°C) with indicator light. Infrared lamps with independent lighting switch.



Plaques chauffantes en acier inox AISI 304 en nombreuses dimensions, avec lampes à infrarouges. Chauffage à sec avec thermostat mécanique (+30°/+90°C) et voyant lumineux de fonctionnement. Les lampes peuvent être allumées séparément avec bouton lumineux.



Wärmeplatten in verschiedenen Größen aus Edelstahl AISI 304 mit Infrarotlampen. Die Temperatur wird mit einem mechanischen Thermostat mit Kontrollleuchte geregelt (+30°/+90°C) Infrarotlampen verfügen über einen separaten Schalter.



Placas calientes de acero inoxidable AISI 304 en diferentes medidas con lámparas infrarrojas. Calentamiento en seco con termostato mecánico (+30°/+90°C), con luz de encendido. Lámparas con encendido independiente y pulsador luminoso.

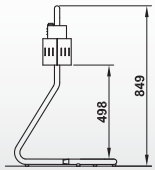

GN 1/1

INFRA 1/1 AL

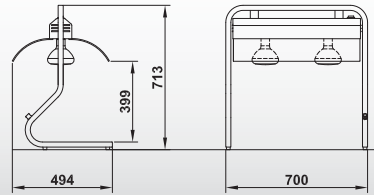

GN 1/1 1/1

INFRA 2/1 AL

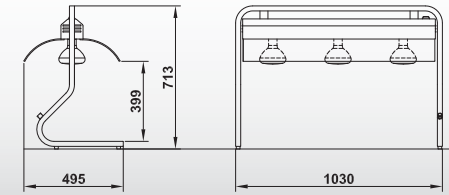

GN 1/1 1/1 1/1

INFRA 3/1 AL

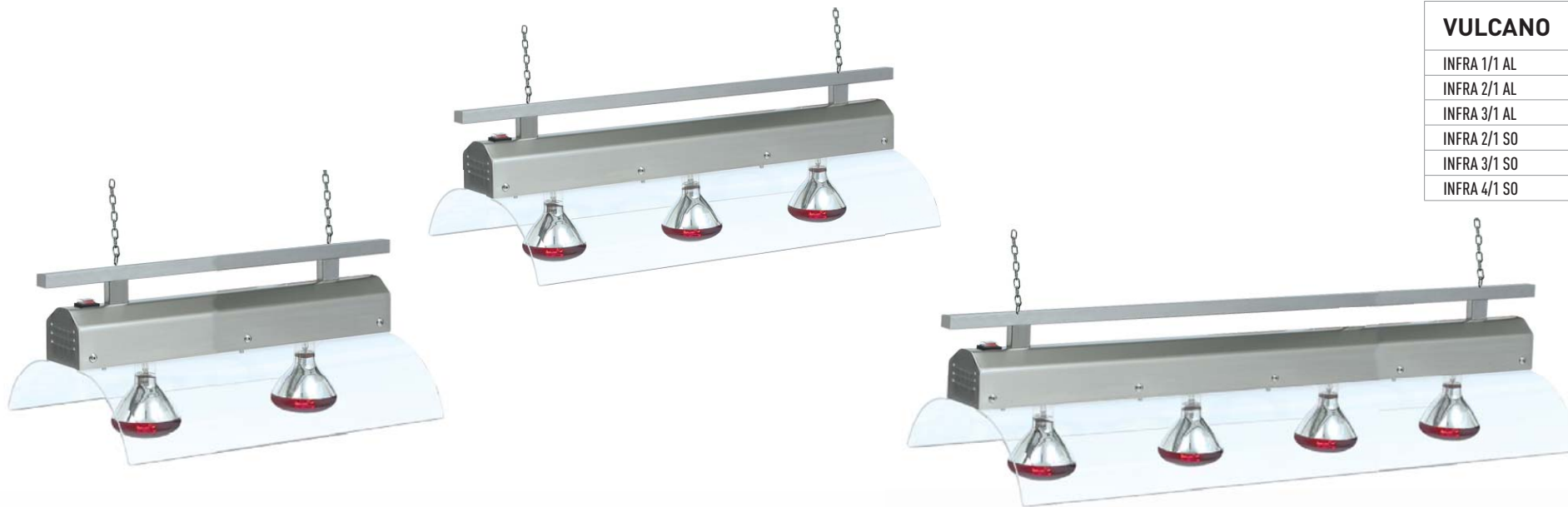

VULCANO	⚡ 230V _{max}	GN
INFRA 1/1 AL	250 W	1 GN 1/1
INFRA 2/1 AL	500 W	2 GN 1/1
INFRA 3/1 AL	750 W	3 GN 1/1
INFRA 2/1 SO	500 W	-
INFRA 3/1 SO	750 W	-
INFRA 4/1 SO	1000 W	-

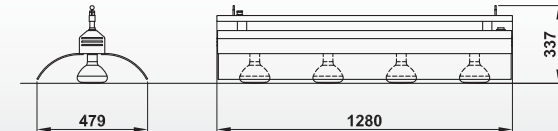
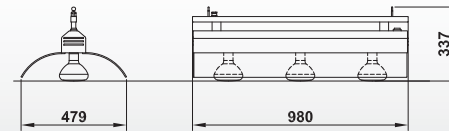
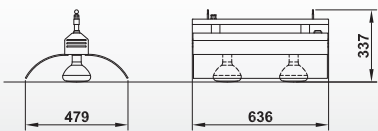

INFRA 2/1 SO

INFRA 3/1 SO

INFRA 4/1 SO



INFRA AL: Struttura da appoggio in tubo in acciaio inox AISI 304 per mantenere i cibi caldi grazie alle lampade ad infrarossi.

INFRA SO: Struttura sospesa da appendere al soffitto per un riscaldamento senza ingombri sul piano di lavoro.



INFRA AL: Free stand structure made of AISI 304 stainless steel tube with infrared lamps for a perfect food heating.

INFRA SO: Hanging infrared structure to be fixed to the ceiling, for a perfect food heating without any encumbrance on the working area.



INFRA AL: Structure d'appui en tube inox AISI 304 avec lampes à infrarouges pour garder les aliments en chaud.
INFRA SO: Voûte à accrocher au plafond pour un chauffage sans encombrement sur la surface de travail.



INFRA AL: Freistehende Rahmenkonstruktion aus Edelstahl AISI 304 mit integrierter Infrarotlampe für eine perfekte Warmhaltung der Speisen.
INFRA SO: Infrarotlampen für Deckenmontage.



INFRA AL: Estructura de apoyo tubular en acero inoxidable AISI 304 para mantener los alimentos calientes gracias a las lámparas infrarrojas.

INFRA SO: Estructura suspendida para colgar en el techo una calefacción sin cargar la encimera.

CARRELLI BAGNO MARIA - BAIN MARIE TROLLEYS



GN 1/1

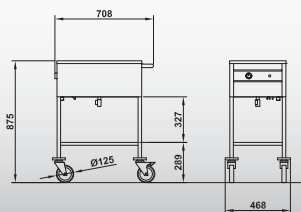

CAPRICORNO 1/1



GN 1/1 1/1

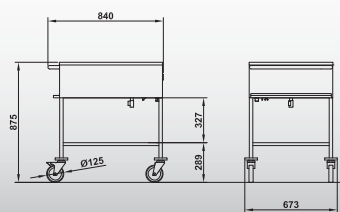

CAPRICORNO 2/1



GN 1/1 1/1 1/1

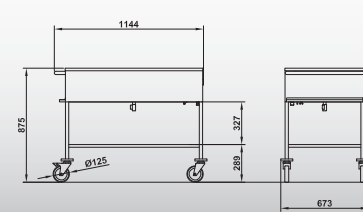

CAPRICORNO 3/1

OPTIONALS



GN



T/S



P/C



CAPRICORNO	⚡ 230V max	GN H 200	OPTIONALS
CAPRICORNO 1/1	2000 W	1 GN 1/1	GN-P/C
CAPRICORNO 2/1	2000 W	2 GN 1/1	GN-T/S-P/C
CAPRICORNO 3/1	2000 W	3 GN 1/1	GN-T/S-P/C
CAPRICORNO 4/1	4000 W	4 GN 1/1	GN-T/S-P/C

CONFIGURA IL TUO CARRELLO
BUILD YOUR TROLLEY ON
www.rocam.it

GN 1/1 1/1 1/1 1/1

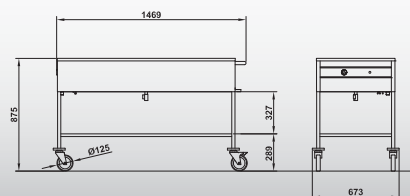

CAPRICORNO 4/1



Carrelli termici in acciaio inox con diverse capacità, da 1xGN1/1 a 4xGN1/1. Vasca con coibentazione a doppia parete profonda 24cm. con rubinetto di scarico. Riscaldamento tramite resistenze elettriche ad immersione con termostato meccanico (+30°/+90°C) e spia luminosa di funzionamento. 4 Paracolpi antitraccia e due ruote con freno di serie. Portacoperchi con teglia raccoglicondensa incluso.



Thermic trolleys with stainless steel structure with different capacity, from 1xGN1/1 up to 4xGN1/1. Well with double insulated walls, 24 cm. depth with drain cock. Bain marie heating with immersion heaters and mechanical thermostat (+30°/+90°C) with indicator light. 4 Non-marking bumpers and two castors with brake included. Lid-holder with condensed-steam tray collector included.



Chariots thermiques en acier inox avec différentes capacités: de 1GN1/1 à 4GN1/1. Bac isolée à double paroi et profonde 24 cm. avec robinet de vidange. Chauffage par résistances à immersion, thermostat mécanique (+30°/+90°C) et voyant lumineux de fonctionnement. 4 Pare-chocs anti-trace et 2 roues à frein de série. Porte-couvercles avec cuvette pour la collecte de la condensation inclus.



Warmhaltewagen aus Edelstahl AISI 304 in unterschiedlichen Ausführungen, von 1xGN1/1 bis 4xGN1/1 verfügbar. Wannen sind doppelt isoliert, 24 cm tief und mit Ablasshahn ausgestattet. Die Temperatur wird durch einen mechanischen Thermostat mit Kontrolleuchte geregelt (+30°/+90°C). 4 Lenkrollen mit Abweisingen, davon 2 Bremsrollen. Inklusiv Deckel-Halterung mit Wanne passend für die Kondensation Sammlung.



Carros térmicos en acero inoxidable en diferentes medidas, de 1xGN1/1 hasta 4xGN1/1. Cuba con doble pared aislada profunda 24 cm. y grifo de drenaje. Calentamiento a través resistencias eléctricas de inmersión con termostato mecánico (+30°/+90°C) y luz de encendido. 4 parachoques que no dejan marcas y dos ruedas con freno incluidas. Soporte para tapas con cuba de recogida para la condensación incluida.

CARRELLI BAGNO MARIA - BAIN MARIE TROLLEYS



GN max H 150

GN max H 200

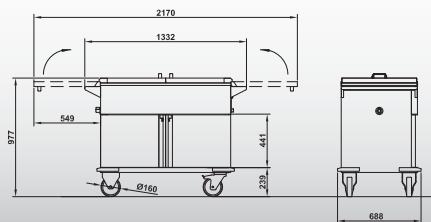

GN H 200 1/1 1/1 1/1

TORO 3/1 CH

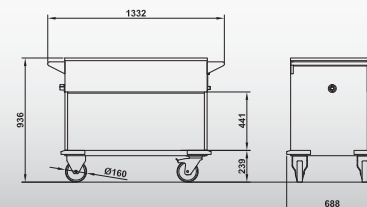

GN H 200 1/1 1/1 1/1

TORO 3/1 AP

OPTIONALS



P



ESTR



L



R 500W



TORO 3/1 CH





TORO	⚡ 230V max	GN H 200	OPTIONALS
TORO 2/1 AP	1500 W	2 GN 1/1	ESTR-L-GN-P
TORO 2/1 CH	1500 W	2 GN 1/1	ESTR-L-R-GN-P
TORO 3/1 AP	2250 W	3 GN 1/1	ESTR-L-GN-P
TORO 3/1 CH	2250 W	3 GN 1/1	ESTR-L-R-GN-P

CONFIGURA IL TUO CARRELLO
BUILD YOUR TROLLEY ON
www.rocam.it

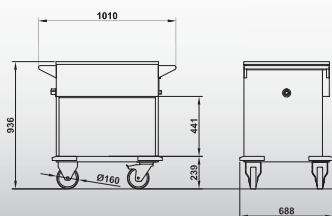

GN H 200 1/1 1/1

TORO 2/1 AP

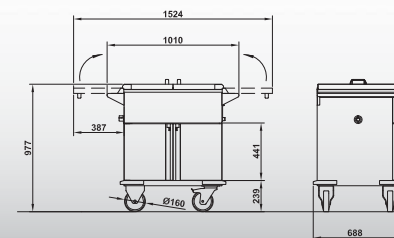

GN H 200 1/1 1/1

TORO 2/1 CH



Carrelli termici in acciaio inox con 2 diverse capacità. Vasca coibentata a doppia parete profonda 21cm. con rubinetto di scarico, riscaldamento sia a secco che a bagnomaria tramite resistenze elettriche poste sotto la vasca, con termostato meccanico (+30°/+90°C) e spia luminosa di funzionamento. 4 Paracolpi antitraccia e due ruote con freno di serie.

TORO CH: coperchi apribili a 180° e sportelli inferiori apribili a 270°, vano inferiore riscaldato su richiesta (opt.R).



Thermic trolleys with stainless steel structure with 2 different capacity. Well with double insulated walls, 21 cm. depth, with drain cock, can be used both as dry or bain marie heaters thanks to electric heating elements placed underneath the well, mechanical thermostat (+30°/+90°C) with indicator light. 4 Non-marking bumpers and two castors with brake included.

TORO CH: lids can be overturned up to 180°, lower doors can be opened up to 270°, lower cupboard can be heated on request (opt. R).



Chariots thermiques en acier inox avec 2 différentes capacités. Bac isolée à double paroi et profonde 21 cm. avec robinet de vidange. Le chauffage peut être soit à sec soit à bain-marie grâce à les résistances posées sous la bac, thermostat mécanique (+30°/+90°C) et voyant lumineux de fonctionnement. 4 Pare-chocs anti-trace et 2 roues à frein de série.

TORO CH: avec couvercles ouvrants à 180° et portes inférieures ouvrantes à 270°. La partie inférieure peut être chauffée sur demande (opt. R).



Warmhaltungswagen aus Edelstahl AISI 304, in 2 Größen erhältlich. Mit doppelt isolierten Wannen, Tiefe 21 cm und Ablasshahn ausgestattet. Kann sowohl mit Trocken-oder Wasserbad Heizung betrieben werden. Die Temperatur wird durch einen mechanischen Thermostat mit Kontrollleuchte geregelt (+30°/+90°C). 4 Stoßschutzecken und 4 Lenkrollen, davon 2 Bremsrollen, inklusive. TORO CH: Deckel sind als praktische Ablage zu verwenden. Die untere Türen können bis zu 270° geöffnet werden. Unterschrank kann mit Option R beheizt werden.



Carros térmicos en acero inoxidable en dos medidas. Cuba con doble pared aislada profunda 21 cm. y grifo de drenaje, calentamiento en seco y también baño maría gracias a sus resistencias colocadas bajo la cuba. Termostato mecánico (+30°/+90°C) y luz de encendido. 4 Parachoques que no dejan marcas y dos ruedas con freno incluidas.

TORO CH: tapas con abertura 180° y puertas en la parte inferior con abertura hasta 270°, compartimento inferior con calefacción sobre pedido (opt. R).

ARMADI CALDI O SCALDAPIAZZI - FOOD OR DISHWARMER



60 x Ø 32 cm



30 x Ø 32 cm



120 x Ø 32 cm



80 x Ø 32 cm



OPTIONALS

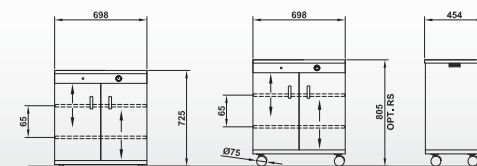
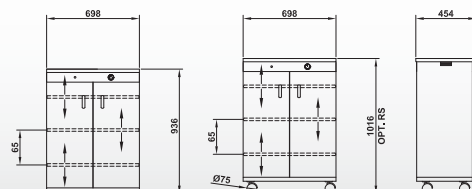
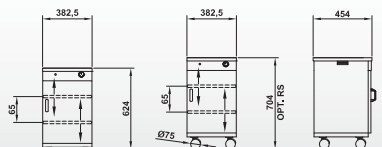
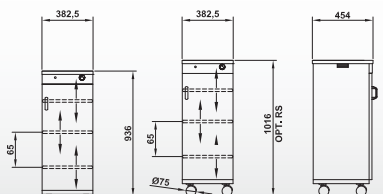

GEMMA 60

GEMMA 30

GEMMA 120

GEMMA 80



Armadi riscaldati in acciaio inox con coibentazione a doppia parete utilizzabili come scaldapiatti o per tenere in caldo i cibi. Riscaldamento a secco con resistenza interna al vano, termostato meccanico (+30°/+90°C) e spia luminosa di funzionamento. Ripiani regolabili in filo d'acciaio, su richiesta possono essere dotati di ruote (no GEMMA 30), di cui 2 con freno (opt. RS).



Stainless steel hot cabinets with double insulated walls usable as dish or food warmers. Dry-heating with heating element placed inside the cabinet, mechanical thermostat (+30°/+90°C) with indicator light. With adjustable grids, on request can be fitted with castors (not GEMMA 30), 2 with brake (opt. RS).



Armoires chauffées sur roues en acier inox isolés à double paroi. Ils peuvent être utilisés comme chauffe-assiettes ou pour garder en chaud les aliments. Chauffage à sec avec résistance dans l'armoire, thermostat mécanique (+30°/+90°C) et voyant lumineux de fonctionnement. Avec étagères réglables en fil d'acier, sur demande peuvent être montés les roues (GEMMA 30 exclus), dont 2 à frein de série (opt. RS).



Wärmeschränke aus Edelstahl AISI 304 mit doppelt isolierten Wänden. Verwendbar als Tellerwärmer oder zur Warmhaltung von Speisen. Trocken Heizung mit Heizelement im inneren des Gehäuses. Die Temperatur wird durch einen mechanischen Thermostat mit Kontrollleuchte geregelt (+30°/+90°C) Ausgestattet mit Einlegegitter. Auf Wunsch, mit Lenkrollen (nicht GEMMA 30), davon 2 Bremsrollen (opt. RS).



Gabinets calientes en acero inoxidable con doble pared aislada, para calentar los platos o para mantener calientes las comidas. Calentamiento en seco con resistencias internas al compartimento. Termostato mecánico (+30°/+90°C) y luz de encendido. Estantes ajustables en alambre de acero, sobre pedido se pueden proporcionar con 4 ruedas (no GEMMA 30), 2 con freno (opt. RS).



	⚡ 230V max	GN H 200	OPTIONALS
CERVO 1/1	2000 W	2 GN 1/1	GN-CANOPO
CERVO 2/1	2000 W	2 GN 1/1	GN-CANOPO
CERVO 3/1	2000 W	3 GN 1/1	GN-CANOPO
GEMMA	500 W	-	GN-CANOPO
GEMMA	700 W	-	RS-GR
GEMMA	1000 W	-	RS-GR
GEMMA	1500 W	-	RS-GR

SCHEDE TECNICHE
TECHNICAL SHEET
www.rocamlt

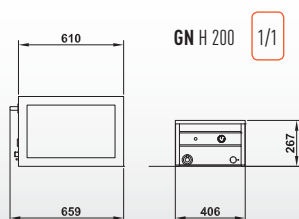

GN H 200 1/1

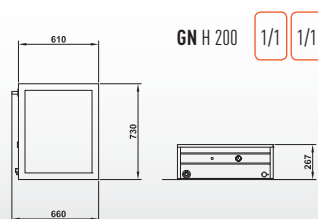

GN H 200 1/1 1/1

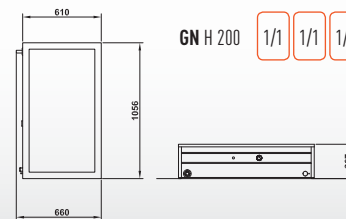

GN H 200 1/1 1/1 1/1

CERVO 1/1

CERVO 2/1

CERVO 3/1

OPTIONALS



CANOPO



Tavole calde in acciaio inox con coibentazione a doppia parete con rubinetto di scarico. Riscaldamento tramite resistenze elettriche ad immersione con termostato meccanico (+30°/+90°C) e spia luminosa di funzionamento.



Stainless steel bain-marie with double wall insulation with drain cock. Bain marie heating with immersion heaters and mechanical thermostat (+30°/+90°C) with indicator light.



Tables chauffantes en acier inox avec isolation à double paroi et robinet de vidange. Chauffage par résistances à immersion, thermostat mécanique (+30°/+90°C) et voyant lumineux de fonctionnement.



Bain Marie mit einer Doppelwandisolierung und Ablasshahn. Die Temperatur wird durch einen mechanischen Thermostat mit Kontrollleuchte gesteuert (+30°/+90°C), Heizung durch Immersionselement.



CERVO: mesas calientes en acero inoxidable con doble pared aislada y grifo de drenaje. Calentamiento a través resistencia eléctrica de inmersión con termostato mecánico (+30°/+90°C) y luz de encendido.



VEGA 1/1 C16 R



VEGA 2/1 C16 R



VEGA 1/1 L10+10 R
VEGA 1/1 C16+16 R

OPTIONALS



GN



K



GR



PROFILO PER VASCHE GN
PROFILE FOR GN PANS



PROFILO PER VASSOI
PROFILE FOR TRAYS

VEGA 1/1 C16 R

GN H 200 1/1

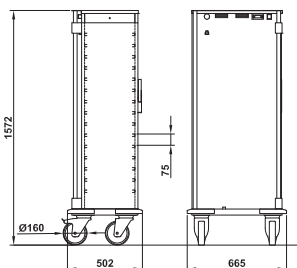

VEGA 1/1 L10 R

1/1

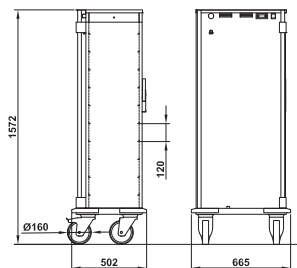

VEGA	⚡ 230V max	C L	⏏	OPTIONALS
VEGA 1/1 C16 R	2000 W	16 L	75 mm	GN-K-GR
VEGA 1/1 L10 R	2000 W	10 L	120 mm	K-GR
VEGA 1/1 C16+16 R	4000 W	16+16	75 mm	GN-K-GR
VEGA 1/1 L10+10 R	4000 W	10+10	120 mm	K-GR
VEGA 2/1 C16 R	2000 W	16	75 mm	GN-K-GR

CONFIGURA IL TUO CARRELLO
BUILD YOUR TROLLEY ON
www.rocamin.it

VEGA 1/1 C16+16 R

GN H 200 1/1 1/1

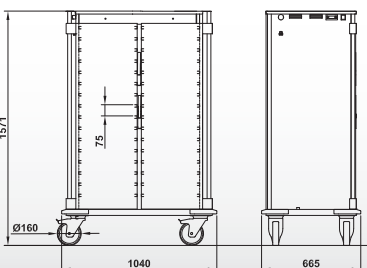

VEGA 1/1 L10+10 R

1/1 1/1

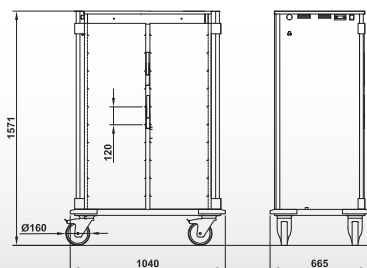

VEGA 2/1 C16 R

GN H 200 1/1 1/1

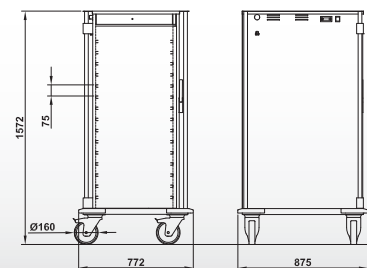

Armadi su ruote riscaldati in acciaio inox con coibentazione a doppia parete per il trasporto di vasche GN o vassoi. Guide di sostegno a "C" antiribaltamento per vasche GN o a "L" per vassoi. Riscaldamento a secco e termostato digitale con pulsante luminoso. Sportelli con guarnizione a tenuta termica, pratici maniglioni di spinta, 4 paracolpi angolari e 2 ruote con freno di serie.



Stainless steel hot cabinets on castors with double insulated walls for GN pans and trays. "C-shaped" or "L-shaped" inner guides for GN pans or trays. Dry-heating with digital thermostat with lighting switch. Equipped with doors with thermic gasket, functional pushing-handles, 4 non-marking bumpers and 2 castors with brake.



Armoires chauffées sur roues en acier inox isolés à double paroi pour le transport de bacs GN ou plateaux. Guides de soutien à "C" anti-renversement pour bacs GN ou à "L" pour plateaux. Chauffage à sec avec thermostat numérique et voyant lumineux de fonctionnement. Portes avec joint à tenue thermique, pratiques poignées de poussée, 4 pare-chocs angulaires et 2 roues à frein de série.



Wärme Schränke aus AISI 304 Edelstahl auf Rollen mit doppelt isolierten Wänden für GN Wannen und Tablett. "C-förmige" oder "L-förmigen" Innenführungen. Dry-Heizung mit Heizelement im inneren des Gehäuses. Die Temperatur wird durch einen digitalen Thermostat mit Lichtschalter gesteuert. Die Türen sind mit thermischer Dichtung und Einschiebegriffe ausgestattet. 4 Stoßschutzecken und 4 Lenkrollen, davon 2 Rollen mit Bremse, sind inklusive.



Gabinets sobre ruedas en acero inoxidable con doble pared aislada para el transporte de bandejas y cubetas GN. Guías de apoyo con perfil "C" antivuelco para cubas GN o con perfil "L" para bandejas. Calentamiento en seco con resistencias internas. Regulación temperatura con termostato digital y pulsador luminoso. Dotados de puertas con junta de estanqueidad térmica, práctica manija de empuje, 4 parachoques angulares y dos ruedas con freno incluidas.

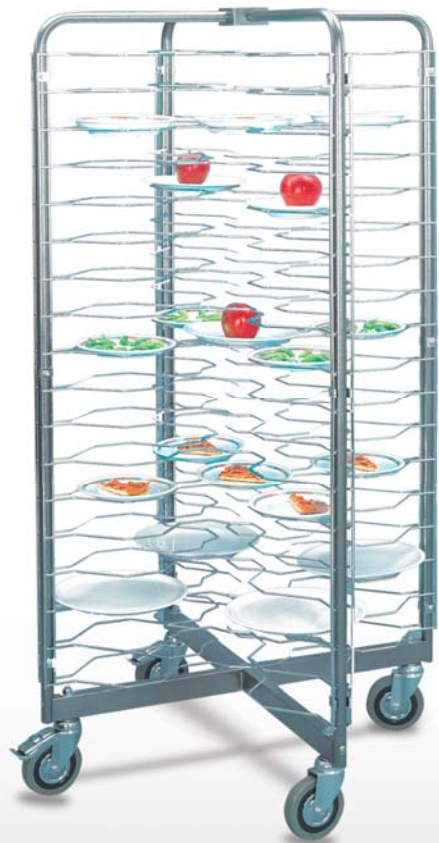

OPTIONALS



7,5 cm

90 x Ø 26 cm
72 x Ø 27-32 cm

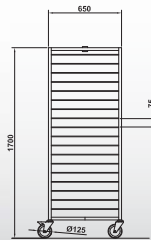

IDRA



Per la lo stoccaggio e il trasporto dei piatti e dei cestelli sono disponibili diverse alternative in acciaio inox AISI 304. IDRA: con la sua struttura portante all'esterno impedisce la caduta del carrello stesso in caso di urto accidentale. La conformazione delle griglie permette di alloggiare piatti di diverse misure aumentandone la capacità. URANO: Carrello per il trasporto dei piatti in acciaio, su richiesta griglie divisorie (Opt. D/IN). ERIDE: La sua costruzione totalmente in acciaio inox lo rende

perfetto per l'utilizzo in strutture sanitarie, idoneo per il trasporto dei pasti o come postazione mobile. Dotato di ruote Ø125mm di cui 2 con freno e una pratica maniglia di spinta. TETI: vascone lava verdure totalmente in acciaio dotato di rubinetto troppopieno e di 2 ruote con freno. La griglia sul fondo è inclusa. VEGA 50x50 e BACCO 50x50: pratiche soluzioni per il trasporto dei cestelli lavastoviglie.

OPTIONALS



250 kg

URANO + D/IN (x2)

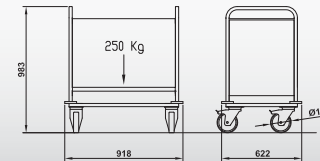

URANO



Several stainless steel AISI 304 alternatives available for the storage and transportation of dishes and dishwasher baskets. IDRA: its external load-bearing structure prevents the fall of the trolley in case of accidental bump. The conformation of the grids allows to insert plates of different sizes increasing its capacity. URANO: St. steel trolley for dish transportation, on request adjustable inner divider grids (Opt. D/IN). ERIDE: Its construction entirely in st. steel makes it perfect for use

in health structures, it's suitable for meals transport or as a mobile station, equipped by Ø125mm wheels, 2 with brake and a push handle. TETI: sink trolley in st. steel for fruit and vegetable washing. Equipped by an overflow tap and 2 wheels with brakes. The grid at the bottom is included. VEGA 50x50 and BACCO 50x50: practical solutions to transport the dishwasher baskets.

250 kg

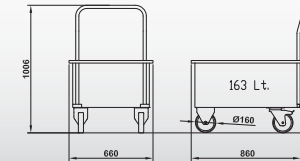

TETI



Nombreuses alternatives en acier inox AISI 304 pour le stockage et le transport des assiettes et des paniers lave-vaisselle. IDRA: avec sa structure portante externe empêche la chute du chariot en cas de choc accidentel. La conformation des grilles permet de positionner plateaux avec dimensions différentes en augmentant la capacité. URANO: chariot en inox pour le transport des assiettes, sur demande grilles de séparation (Opt. D/IN). ERIDE: sa structure complètement en inox le rend parfait

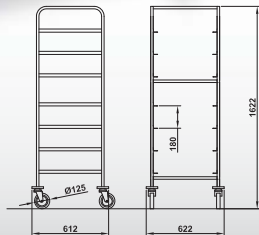

VEGA 50x50

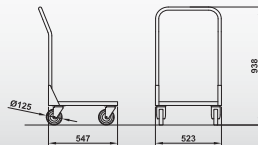

BACCO 50x50

OPTIONALS

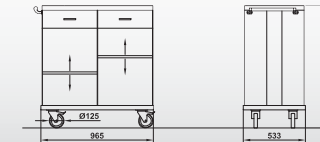

ERIDE

	OPTIONALS
IDRA	IDRA/CO
URANO	D/IN - RF
TETI	-
VEGA 50x50	RF
BACCO 50x50	RF
ERIDE	PP/F

CONFIGURA IL TUO CARRELLO
BUILD YOUR TROLLEY ON
www.rocam.it

OPTIONALS



RF

pour une utilisation dans les établissements de soins de santé, et est adapté au transport des repas ou comme compteur mobile. Doté de roulettes Ø125mm dont 2 à frein et une poignée de pousse. TETI: chariot à évier en inox pour le transport et le lavage des légumes, doté de robinet trop plein et avec 2 roues à frein. La grille sur le fond est incluse. VEGA 50x50 et BACCO 50x50: chariots pour le stockage et le transport des paniers lave-vaisselle.



Verschiedene Alternativen aus Edelstahl AISI 304 für die Lagerung und den Transport der Platten und die Körbe. IDRA: die äußere Tragstruktur verhindert den Fall des Wagens mit zufälligen Beule. Die Gitterform ermöglicht die Platzierung der Platten mit verschiedenen Größen. URANO: Teller-Transportwagen aus Edelstahl. Verstellbare Inneneinteiler (Opt. D/IN). ERIDE: Edelstahlwagen ideal für die Benutzung in Gesundheitseinrichtungen für den Transport von

Mahlzeiten oder als Mobilstation. Mit Rädern Ø125mm, 2 mit Bremse und mit einem praktischen Schiebegriff ausgestattet. TETI: niedriger Wagen zum Obst und Gemüse waschen. Mit Ablassschraube, Schutzgitter und 2 Rollen mit Bremse. VEGA 50x50 und BACCO 50x50: Transportwagen für Spülmaschinenkörbe.



Diferentes alternativas en acero inoxidable AISI 304 para el almacenamiento y el transporte de platos y cestas lavavajillas. IDRA: con su estructura al exterior evita la caída del carro en caso de impacto accidental. La conformación de las rejillas permite de acomodar platos de tamaños diferentes aumentando su capacidad. URANO: Carro para el transporte d los platos, sobre pedido rejillas divisoras (Opt. D/IN). ERIDE: su construcción en acero inoxidable es perfecto

para el uso en centros de salud, y puede ser utilizado para el transporte de las comidas o como estación móvil. Equipado con 2 ruedas Ø125mm con freno y una manija de empuje. TETI: carro para transportar y lavar verduras, equipado de sistema de desagüe con rejilla de protección Rejilla interna desmontable y 2 ruedas con freno. VEGA 50 x 50 y BACCO 50x50: carros almacenamiento y transporte cestas lavavajillas.



VEGA GN 1/1 L18

VEGA GN 1/1 C16

VEGA GN 1/1 C8+8

VEGA GN 1/1 C8

VEGA GN 2/1 L18

VEGA GN 2/1 C16

OPTIONALS



GN



RF



PROFILO PER VASCHE GN
PROFILE FOR GN PANS



PROFILO PER VASSOI
PROFILE FOR TRAYS

VEGA GN 1/1 L18

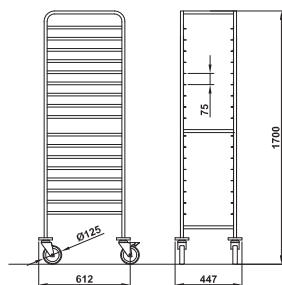

VEGA GN 1/1 C16

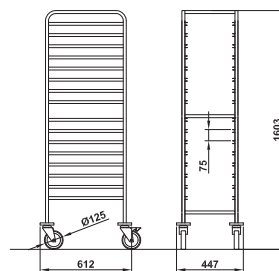

VEGA GN 1/1 C8+8

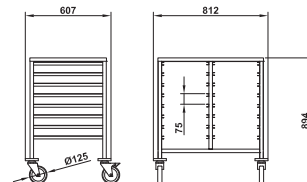

VEGA GN 1/1 C8

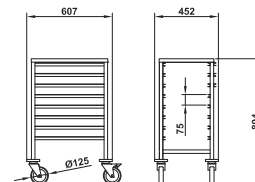

VEGA GN 2/1 L18

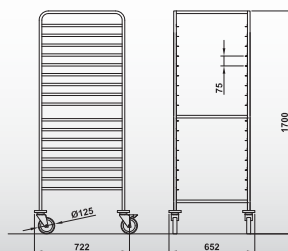

VEGA GN 2/1 C16

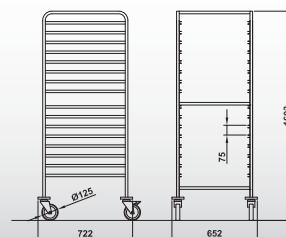

VEGA GN 2/1 C8

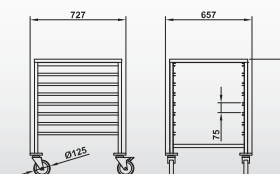

VEGA	C L	H	OPTIONALS
VEGA GN 1/1 C8+8	8+8 C	7,5 cm	RF-GN
VEGA GN 1/1 C16	16 C	7,5 cm	RF-GN
VEGA GN 1/1 L18	18 C	7,5 cm	RF
VEGA GN 1/1 C8	8 L	7,5 cm	RF-GN
VEGA GN 2/1 C8	8 C	7,5 cm	RF-GN
VEGA GN 2/1 C16	16 C	7,5 cm	RF-GN
VEGA GN 2/1 L18	18 L	7,5 cm	RF

CONFIGURA IL TUO CARRELLO
BUILD YOUR TROLLEY ON
www.rocaml.it



VEGA GN 2/1 C8



Carrelli in acciaio inox AISI 304 per il recupero o la distribuzione di vasche o vassoi GN. Guide di sostegno antiribaltamento a "C" o a "L". Tutti i modelli sono dotati di serie di 4 paracolpi antitraccia e di 4 ruote girevoli, su richiesta disponibili con 2 ruote con freno (opt. RF).



Rack trolleys with AISI 304 stainless steel structure for GN pans and trays storage. "C-shaped" or "L-shaped" guides. All models are equipped with 4 non-marking bumpers and 4 swiveling castors, on request can be fitted with 2 castors with brake (opt. RF).



Chariots en acier inox AISI 304 pour le ramassage ou la distribution de bacs ou plateaux GN. Guides de soutien anti-renversement à "C" ou a "L". Tous les modèles sont dotés de 4 pare-chocs anti-trace de série et de 4 roues pivotantes, sur demande 2 roues peuvent être à frein (opt. RF).



Regalwagen aus Edelstahl AISI 304 für GN Wannen und Tabletts. "C-förmige" oder "L-förmige" Führungen. Alle Modelle sind mit 4 Lenkrollen mit Abweisingen ausgestattet. Auf Wunsch kann dieser Wagen mit 2 Bremsrollen ausgestattet werden (opt. RF).



Carros en acero inoxidable AISI 304 para la recogida o la distribución de cubas o bandejas GN. Guías de apoyo antivuelco con perfil "C" o "L". Todos los modelos se proporcionan con 4 parachoques que no dejan marcas y con 4 ruedas pivotantes. Sobre pedido están disponibles también con 2 ruedas con freno (opt. RF).



VEGA 12



VEGA 24



VEGA 36

VEGA 12

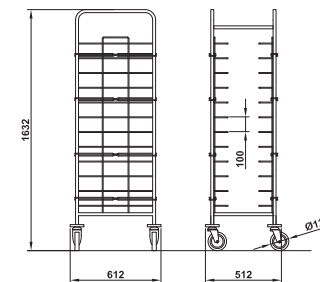

VEGA 24

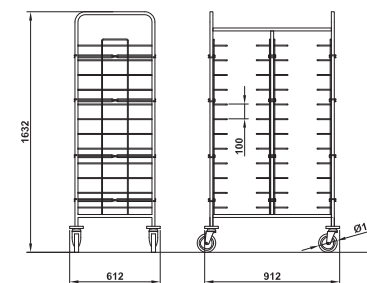

VEGA 36

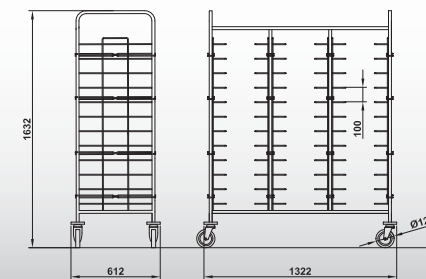

OPTIONALS





VEGA 60x40 L16

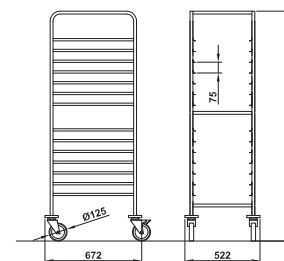

VEGA 60x40 L10

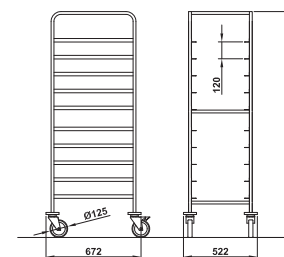

VEGA 60x40 L8

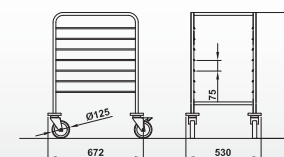

VEGA	□ L	⌈⌋	OPTIONALS
VEGA 60x40 L8	8 □	7,5 cm	RF
VEGA 60x40 L10	10 □	12 cm	RF
VEGA 60x40 L16	16 □	7,5 cm	RF
VEGA 12	12 L	10 cm	RF-P/LAM-P/IN-V
VEGA 24	12+12 L	10 cm	RF-P/LAM-P/IN-V
VEGA 36	12+12+12 L	10 cm	RF-P/LAM-P/IN-V

CONFIGURA IL TUO CARRELLO
BUILD YOUR TROLLEY ON
www.rocamlit

VEGA 60x40 L16

VEGA 60x40 L10

VEGA 60x40 L8



Carrelli in acciaio inox AISI 304 per il recupero o la distribuzione di vassoi o teglie. Guide di sostegno a "L" o in filo d'acciaio cromato. Tutti i modelli sono dotati di serie di 4 paracolpi antiraccia e di 4 ruote girevoli, su richiesta disponibili con 2 ruote con freno (opt. RF).



Rack trolleys with AISI 304 stainless steel structure for baking pans and trays storage. "L-shaped" guides or chromed wire steel. All models are equipped with 4 non-marking bumpers and 4 swiveling castors, on request can be fitted with 2 castors with brake (opt. RF).



Chariots en acier inox AISI 304 pour le ramassage ou la distribution de plateaux ou plaques à four. Guides de soutien a "L" ou en fil chromée. Tous les modèles sont dotés de 4 pare-chocs anti-trace de série et de 4 roues pivotantes, sur demande 2 roues peuvent être à frein (opt. RF).



Regalwagen aus Edelstahl AISI 304 für Backformen oder Tablett. "L-formige" Führungen. Alle Modelle sind mit 4 Lenkrollen mit Abweisingen ausgestattet. Auf Wunsch kann dieser Wagen mit 2 Bremsrollen ausgestattet werden (opt. RF).



Carros en acero inoxidable AISI 304 para la recogida o la distribución de bandejas o platos de horno. Guías de apoyo con perfil "L". Todos los modelos se proporcionan con 4 parachoques que no dejan marcas y con 4 ruedas pivotantes. Sobre pedido están disponibles también con 2 ruedas con freno (opt. RF).

 250 kg



 250 kg



 500 kg



BACCO 80

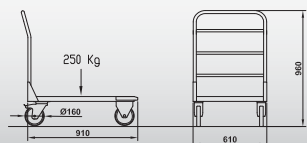

BACCO 100

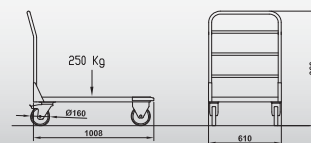

BACCO RINF

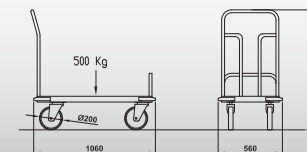

OPTIONALS



RF



C/N

 250 kg



 250 kg



	OPTIONALS
BACCO 80	RF
BACCO 100	RF
BACCO RINF	RF
CERERE RINF	C/IN
DRAGONE RINF	C/IN

CONFIGURA IL TUO CARRELLO
BUILD YOUR TROLLEY ON
www.rocamin.it

DRAGONE RINF

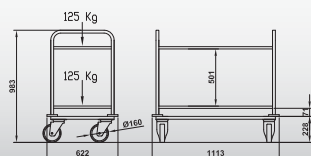

CERERE RINF

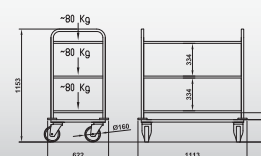

Carrelli di servizio o per lo sbarazzo completamente in acciaio inox AISI 304 a 2 o a 3 piani insonorizzati completamente saldati per una grande portata con ruote Ø160mm e 4 paracolpi antitraccia di serie (RINF).
BACCO: carrello piattaforma in acciaio inox AISI 304 per il trasporto di merci, due ruote fisse e due girevoli di serie, dotato di due paracolpi antitraccia e di una funzionale maniglia di spinta.



Service or table-clearing trolleys with AISI 304 stainless steel structure with 2 or 3 noiseproof completely welded tiers for a higher payload, Ø160mm castors and 4 non-marking bumpers included (RINF).
BACCO: platform trolley with AISI 304 stainless steel structure, 2 fixed and 2 swiveling castors included, equipped with 2 non-marking bumpers and a functional pushing-handle.



Chariots de service ou pour débarasser complètement en acier AISI 304 à 2 ou 3 étagères insonorisés et complètement soudés pour une grande charge, roues Ø160 mm. et pare-chocs anti-trace de série (RINF).
BACCO: chariot plateforme en acier inox AISI 304 pour le transport de marchandises, 2 roues fixes et 2 pivotantes de série et doté de 2 pare-chocs anti-trace et d'une poignée de poussée.



Service- und Abräumwagen aus Edelstahl AISI 304 mit 2 oder 3 Etagen. Komplett verschweißte Etagen für eine höhere Nutzlast. Inklusive Ø 160mm Rollen und 4 Abweiser (RINF).
BACCO: Plattformwagen aus Edelstahl AISI 304. Inklusive 2 Bock- und 2 Lenkrollen, 2 Stoßschutzecken vorne.



Carros servicio y recogida en acero inoxidable AISI 304 con 2 o 3 estantes insonorizados, totalmente soldados para soportar grandes cargas, ruedas Ø160mm y 4 parachoques que no dejan marcas incluidos (RINF).
BACCO: carro plataforma de acero inoxidable AISI 304 para cargas, 2 ruedas fijas y 2 giratorias incluidas, equipado de dos parachoques que no dejan marcas y manija de empuje.

 150 kg





150 kg



ALFA

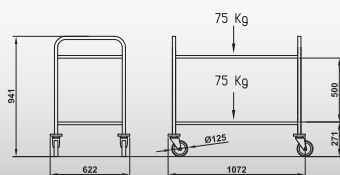

ALFA C/SP

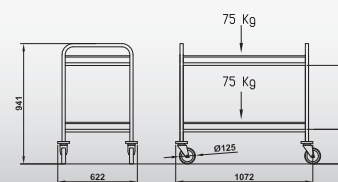

OPTIONALS



RF

 150 kg

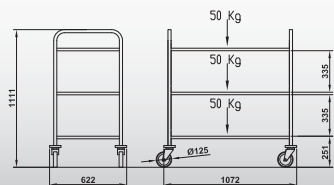

BETA

 150 kg

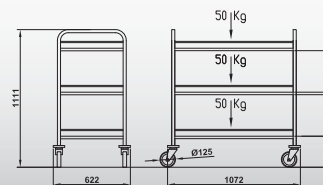

BETA C/SP

	OPTIONALS
ALFA	RF-C/IN
ALFA C/SP	RF-C/IN
BETA	RF-C/IN
BETA C/SP	RF-C/IN

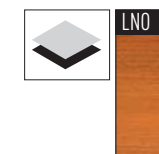

CONFIGURA IL TUO CARRELLO
BUILD YOUR TROLLEY ON
www.rocam.it



ALFA-BETA: Carrelli per lo sbarazzo a 2 o 3 piani con struttura in acciaio inox AISI 304 e piani in legno laminato color noce. Disponibile anche la versione con spondine di contenimento (C/SP).



ALFA-BETA: Table clearing trolleys with 2 or 3 tiers with AISI 304 stainless steel structure and walnut laminated wood shelves, available also with protection frames on all tiers (C/SP).



ALFA-BETA: Chariots pour debarasser à 2 ou 3 niveaux avec structure en acier inox AISI 304 et étagères en bois melaminé couleur noyer. Disponible aussi la version avec galeries de protection (C/SP).



ALFA-BETA: Servier- Abräumwagen mit 2 oder 3 Etagen aus Edelstahl AISI 304 und laminiertem Walnussholz. Auch mit streben als Fallschutz auf allen Ebenen verfügbar (C/SP).



ALFA-BETA: Carros recogida con 2 o 3 estantes y estructura en acero inoxidable AISI 304. Estantes de madera laminada color nogal, disponible también con barandillas de protección (versión C/SP).

CARRELLI SBARAZZO - TABLE CLEARING TROLLEYS

 150 kg



 150 kg



 150 kg

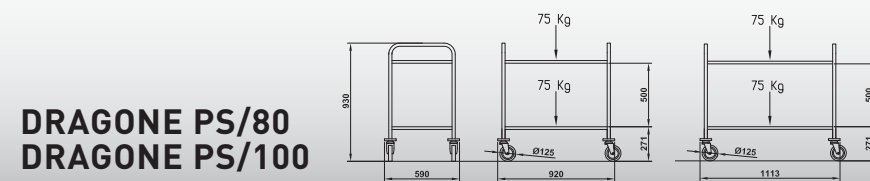
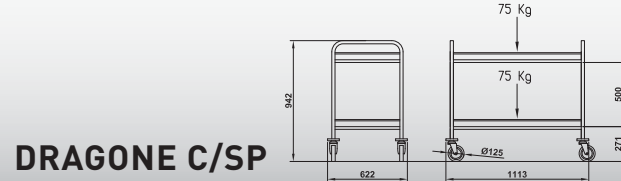
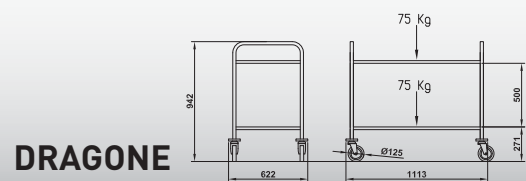

OPTIONALS



 150 kg



 150 kg



 150 kg



	OPTIONALS
DRAGONE	C/IN-RF
DRAGONE C/SP	C/IN-RF
DRAGONE PS/80	C/IN-RF
DRAGONE PS/100	C/IN-RF
CERERE	C/IN-RF
CERERE C/SP	C/IN-RF
CERERE PS/80	C/IN-RF
CERERE PS/100	C/IN-RF

CONFIGURA IL TUO CARRELLO
BUILD YOUR TROLLEY ON
www.rocamlit

CERERE

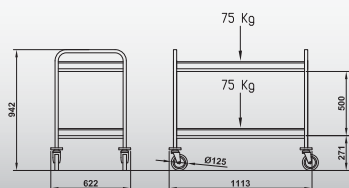

**CERERE PS/80
CERERE PS/100**

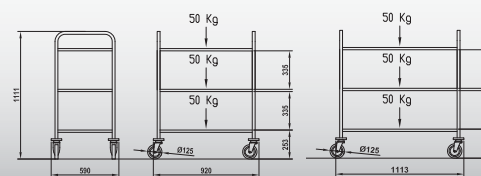

CERERE C/SP

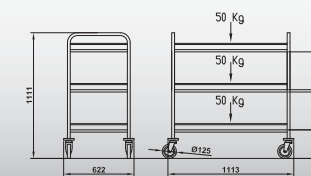

Carrelli di servizio o per lo sbarazzo completamente in acciaio inox AISI 304 a 2 o a 3 piani insonorizzati. Disponibili anche nelle versioni con spondine di contenimento [C/SP] e con piani stampati (PS/80-PS/100). 4 Paracolpi antiraccia e 4 ruote girevoli di serie. Su richiesta disponibile un pratico contenitore per rifiuti in acciaio inox (opt. C/IN).



Service or table-clearing trolleys with AISI 304 stainless steel structure with 2 or 3 noiseproof tiers. Available also with protection frames on all tiers (C/SP) and with moulded shelves (PS/80-PS/100). 4 Non-marking bumpers and 4 swiveling castors included. Functional stainless steel litter container available on request (opt. C/IN).



Chariots de service ou pour débarasser, complètement en acier AISI 304 à 2 ou 3 étagères insonorisés. Disponibles aussi les versions avec galeries de protection (C/SP) ou avec étagères emboutis (PS/80-PS/100). 4 Pare-chocs anti-trace et 4 roues pivotantes de série. Sur demande un box à poubelle en inox (opt. C/IN).



Service- und Abräumwagen aus Edelstahl AISI 304 mit 2 oder 3 Etagen. Erhältlich auch mit zusätzlichen Streben (Fallschutz) auf allen Ebenen (C/SP) und geprägte Etagen (PS/80-PS/100). 4 Lenkrollen mit Abweisingen sind enthalten. Funktionaler Abfallbehälter aus Edelstahl auf Anfrage (Opt. C/IN).



Carros servicio y recogida en acero inoxidable AISI 304 con 2 o 3 estantes insonorizados. Disponibles también con barandillas de protección (versión C/SP) y estantes moldeados (PS/80-PS/100). 4 Parachoques que no dejan marcas y 4 ruedas pivotantes incluidas. Sobre pedido se proporcionan con práctico contenedor de residuos en acero inoxidable (opt. C/IN).



	OPTIONALS
DRAGONE 1/V	RF-C/IN
DRAGONE 2/V	RF-C/IN

CONFIGURA IL TUO CARRELLO
BUILD YOUR TROLLEY ON
www.rocamin.it

DRAGONE 1/V

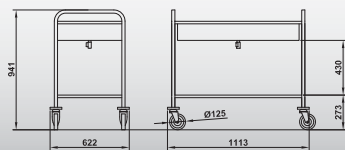

DRAGONE 2/V

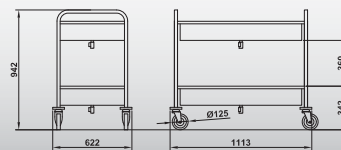

OPTIONALS



Carrelli di servizio o per lo sbarazzo completamente in acciaio inox AISI 304 a 1 o 2 vasche e 4 paracolpi antitraccia di serie. Ogni vasca ha una capacità di 3 GN 1/1 h. 150mm. ed è dotata di rubinetto di scarico.



Stainless steel AISI 304 service or table-clearing trolleys with 1 or 2 wells and with 4 non marking bumpers included. Each well is 3 GN 1/1 h. 150mm. and is completed by a drain cock.



Chariots de service ou pour débarasser à 1 ou 2 bacs complètement en acier inox AISI 304. Pare-chocs anti-trâche de série. Chaque bac à une capacité de 3 GN1/1 h. 150mm. Et est dotée d'un robinet de vidange.



Service- und Abräumenwagen aus Edelstahl AISI 304 mit 1 oder 2 Wannen. Jede Wanne ist 3 GN1/1 h. 150mm. Mit Ablaufhahn erhältlich.



Carros servicios y recogida en acero inox AISI 304 con 1 o 2 cubas. Para-golpes que no dejan marcas incluidos. Casa cuba tiene un tamaño de 3 GN1/1 h.150mm., grifo de drenaje incluido.

GN						
	53 x 32,5 cm	35,4 x 32,5 cm	32,5 x 26,5 cm	32,5 x 17,6 cm	26,5 x 16,2 cm	26,5 x 16,2 cm
H 200	28 lt	18 lt	12,5 lt	7,8 lt	5,5 lt	3,4 lt
H 150	21 lt	13 lt	9,5 lt	5,7 lt	4 lt	2,4 lt
H 100	14 lt	9 lt	6,5 lt	4 lt	2,8 lt	1,6 lt
H 65	9 lt	5,5 lt	4 lt	2,5 lt	1,8 lt	1 lt

COMBINAZIONI COMBINATION		CAPACITÀ PASTI MEAL CAPACITY
1 x GN 1/1		15 > 25
2 x GN 1/1		30 > 50
3 x GN 1/1		45 > 75
4 x GN 1/1		60 > 100
5 x GN 1/1		> 100
6 x GN 1/1		> 125

SIMBOLOGIA - SYMBOLS



REFRIGERATO - REFRIGERATED
RÉFRIGÉRÉ - GEKÜHLT - REFRIGERADO

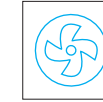

REFRIGERATO VENTILATO - VENTILATED REFRIGERATION
RÉFRIGÉRÉ VENTILÉ - GELÜFTET KÜHLUNG - REFRIGERACIÓN VENTILADA



PIANO REFRIGERATO - REFRIGERATED COUNTERTOP
PLAQUE RÉFRIGÉRÉ - GEKÜHLTEFLÄCHEN - ESTANTE REFRIGERADO



BAGNOMARIA - BAIN-MARIE
BAIN MARIE - BAIN MARIE - BAÑO MARIA

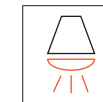

LAMPADE INFRA - INFRARED LAMPS
LAMPES INFRAROUGES - INFRAROTLAMPEN - LÁMPARAS INFRARROJOS



RISCALDATO - WARMED
CHAUFFÉ - BEHEITZT - CALENTADO



SERVITO - WITH OPERATOR
AVEC OPÉRATEUR - MIT OPERATOR - CON OPERADOR



FLAMBÈ - FLAMBÉ
FLAMBÉ - FLAMBÉ - FLAMBÉ









NOS SERVICES

Partout en France, de l'étude personnalisée au montage, les Usines Réunies vous proposent des prestations d'ameublement collectif à la mesure de tous vos projets : le confort clés en main, le style en plus !



MOBILIER



BUREAU D'ÉTUDES



FABRICATION



LIVRAISON & MONTAGE

Retrouvez nos réalisations et toute l'actualité de nos chantiers sur les réseaux sociaux !



FACEBOOK / Les Usines Réunies



Consultez tous nos catalogues en ligne sur www.lesusinesreunies.fr



L A I S S E Z - V O U S I N S P I R E R
P A R N O T R E S H O W R O O M

Espace «Coralia» Bâtiment A
424 rue de Lisbonne
83500 La Seyne-Sur-Mer

TÉL. +33 (0) 4 94 07 04 90
FAX +33 (0) 4 94 07 39 10
accueil@lesusinesreunies.fr

www.lesusinesreunies.fr

